

HD VIDEO SWITCHER V-60HD

Owner's Manual

Before using the V-60HD, ensure that its system program is at the most recent version. For information on available upgrades for the system program, see the Roland website (<https://proav.roland.com/>).

You can check the system program version by pressing the [MENU] button → "SYSTEM" → "VERSION."

Owner's Manual (this document)

Read this first. It explains the basic things you need to know in order to use the V-60HD.

PDF Manual (download from the Web)

- **Reference Manual**

This manual covers all menu items of the V-60HD. It also describes control via RS-232, LAN, and TALLY/GPI.

To obtain the PDF manual

1. Enter the following URL in your computer.
<https://proav.roland.com/>



2. Go to the V-60HD product page and click the "Support."

Contents

USING THE UNIT SAFELY	3
IMPORTANT NOTES	5
Panel Descriptions	6
Top Panel/Side Panel	6
Rear Panel/Front Panel (Connecting Your Equipment)	8
Using Phantom Power	9
Multi-view Monitor Display.....	10
Basic Operations	11
Turning the Power On and Off	11
Operating the Menu.....	11
Video Input/Output Settings	12
Setting the Video Input/Output Format.....	12
Setting the System Format	12
Setting the Input Formats for Channels 5 and 6	12
Assigning a Video Source to Channel 6	13
Adjusting Output Video.....	13
Adjusting the Input Video.....	14
Changing Output Bus Assignments	15
Inputting Copyright-protected (HDCP) Video	15
Video Operations	16
Switching the Video	16
About the Operation Mode for Video Transitions	16
Switching Using the PGM/PST Mode.....	16
Switching in the A/B Mode	17
Switching AUX Output	18
Using Imported Still Images	18
Capturing a Still Image from Input Video	18
Importing a Still Image from a USB Flash Drive	19
Assigning Still Images to Channels 7 and 8	19
Deleting a Still Image	19
Applying a Fade to PGM/PVW Output Video (Output Fade)....	20
Video Composition Operations	21
Compositing Using Picture-in-Picture (PinP).....	21
Compositing Using Split	22
Compositing Using DSK.....	23

Audio Operations	24
Adjusting the Volume Level	24
Adjusting the Head Amp Gain	24
Adjusting the Sound Position (Pan)	24
Adjusting the Volume Balance	25
Outputting AUX-bus Audio.....	25
Applying Effects to Audio	26
Applying Effects to Input Audio	26
Applying Effects to Output Audio	27
Controlling Volume Levels Automatically (Auto Mixing).....	28
Muting Out Specific Input Audio (Mute)	28
Interlinking Audio Output to Video Switching (Audio Follow)..	29
Separating Discrete Analog Input Audio Streams and Adding Them to SDI Video	30
Other Features	31
Saving/Recalling Settings (Preset Memory).....	31
Saving the Unit's Settings on a USB Flash Drive	32
Formatting USB Flash Drives.....	33
Returning Settings to the Factory-default State (Factory Reset)	33
Preventing Unintended Operation (Panel Lock)	34
Operating the V-60HD by Remote Control.....	34
Outputting a Tally Signal.....	34
Appendices	35
Troubleshooting	35
Block Diagram	36
Video Section	36
Audio Section.....	38
Main Specifications	40
Dimensions	41
Transition Effects List	42

Before using this unit, carefully read "USING THE UNIT SAFELY" (p. 3) and "IMPORTANT NOTES" (p. 5). After reading, keep the document(s) where it will be available for immediate reference.

Checking the Included Items

The V-60HD includes the following items. Please take a moment to confirm that all of these items have been included with the V-60HD. If you find that any item is missing, contact the nearest authorized Roland distributor in your country.

The unit



AC Adaptor/Power cord



Owner's Manual



* The shape of the power cord's plug varies depending on the country.

USING THE UNIT SAFELY

INSTRUCTIONS FOR THE PREVENTION OF FIRE, ELECTRIC SHOCK, OR INJURY TO PERSONS

About ⚠ WARNING and ⚠ CAUTION Notices

⚠ WARNING	Used for instructions intended to alert the user to the risk of death or severe injury should the unit be used improperly.
⚠ CAUTION	Used for instructions intended to alert the user to the risk of injury or material damage should the unit be used improperly. * Material damage refers to damage or other adverse effects caused with respect to the home and all its furnishings, as well to domestic animals or pets.

About the Symbols

	The ⚠ symbol alerts the user to important instructions or warnings. The specific meaning of the symbol is determined by the design contained within the triangle. In the case of the symbol at left, it is used for general cautions, warnings, or alerts to danger.
	The ⓧ symbol alerts the user to items that must never be carried out (are forbidden). The specific thing that must not be done is indicated by the design contained within the circle. In the case of the symbol at left, it means that the unit must never be disassembled.
	The ⓪ symbol alerts the user to things that must be carried out. The specific thing that must be done is indicated by the design contained within the circle. In the case of the symbol at left, it means that the power-cord plug must be unplugged from the outlet.

ALWAYS OBSERVE THE FOLLOWING

⚠ WARNING

To completely turn off power to the unit, pull out the plug from the outlet

Even with the power switch turned off, this unit is not completely separated from its main source of power. When the power needs to be completely turned off, turn off the power switch on the unit, then pull out the plug from the outlet. For this reason, the outlet into which you choose to connect the power cord's plug should be one that is within easy reach and readily accessible.



Concerning the Auto Off function

The power to this unit will be turned off automatically after a predetermined amount of time has passed since it was last used for playing music, or its buttons or controls were operated (Auto Off function). If you do not want the power to be turned off automatically, disengage the Auto Off function (p. 11).



Secure a sufficient amount of space at the setup location

Since this unit normally emits a slight amount of heat, make sure to secure sufficient space around it, as shown below.

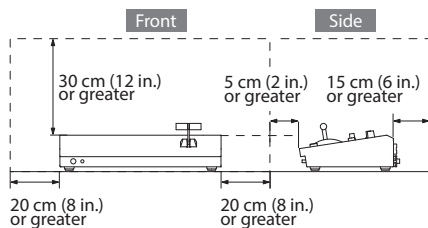

Do not disassemble or modify by yourself

Do not carry out anything unless you are instructed to do so in the owner's manual. Otherwise, you risk causing malfunction.



⚠ WARNING

Do not repair or replace parts by yourself

Refer all servicing to your retailer, the nearest Roland Service Center, or an authorized Roland distributor, as listed on the "Information."



Do not use or store in the following types of locations

- Subject to temperature extremes (e.g., direct sunlight in an enclosed vehicle, near a heating duct, on top of heat-generating equipment); or are
- Damp (e.g., baths, washrooms, on wet floors); or are
- Exposed to steam or smoke; or are
- Subject to salt exposure; or are
- Exposed to rain; or are
- Dusty or sandy; or are
- Subject to high levels of vibration and shakiness; or are
- Placed in a poorly ventilated location.



Do not place in an unstable location

Otherwise, you risk injury as the result of the unit toppling over or dropping down.



Use only the supplied AC adaptor and the correct voltage

Be sure to use only the AC adaptor supplied with the unit. Also, make sure the line voltage at the installation matches the input voltage specified on the AC adaptor's body. Other AC adaptors may use a different polarity, or be designed for a different voltage, so their use could result in damage, malfunction, or electric shock.



Use only the supplied power cord

Use only the attached power cord. Also, the supplied power cord must not be used with any other device.



⚠ WARNING

Do not bend the power cord or place heavy objects on it

Otherwise, fire or electric shock may result.



Avoid extended use at high volume

Use of the unit at high volume for extended periods of time may cause hearing loss. If you ever experience any hearing loss or ringing in the ears, you should immediately stop using the unit and consult a specialized physician.



Do not allow foreign objects or liquids to enter unit; never place containers with liquid on unit

Do not place containers containing liquid (e.g., flower vases) on this product. Never allow foreign objects (e.g., flammable objects, coins, wires) or liquids (e.g., water or juice) to enter this product. Doing so may cause short circuits, faulty operation, or other malfunctions.



Turn off the unit if an abnormality or malfunction occurs

Immediately turn the unit off, remove the AC adaptor from the outlet, and request servicing by your retailer, the nearest Roland Service Center, or an authorized Roland distributor, as listed on the "Information" when:



- The AC adaptor or the power cord has been damaged; or
- If smoke or unusual odor occurs; or
- Objects have fallen into, or liquid has been spilled onto the unit; or
- The unit has been exposed to rain (or otherwise has become wet); or
- The unit does not appear to operate normally or exhibits a marked change in performance.

WARNING

Be cautious to protect children from injury

Always make sure that an adult is on hand to provide supervision and guidance when using the unit in places where children are present, or when a child will be using the unit.



Do not drop or subject to strong impact

Otherwise, you risk causing damage or malfunction.



Do not share an outlet with an unreasonable number of other devices

Otherwise, you risk overheating or fire.



Do not use overseas

Before using the unit in overseas, consult with your retailer, the nearest Roland Service Center, or an authorized Roland distributor, as listed on the "Information."



CAUTION

When disconnecting the power cord, grasp it by the plug

To prevent conductor damage, always grasp the power cord by its plug when disconnecting it.



Periodically clean the power plug

An accumulation of dust or foreign objects between the power plug and the power outlet can lead to fire or electric shock.



At regular intervals, be sure to pull out the power plug, and using a dry cloth, wipe away any dust or foreign objects that may have accumulated.

Disconnect the power plug whenever the unit will not be used for an extended period of time

Fire may result in the unlikely event that a breakdown occurs.



Route all power cords and cables in such a way as to prevent them from getting entangled

Injury could result if someone were to trip on a cable and cause the unit to fall or topple.



Avoid climbing on top of the unit, or placing heavy objects on it

Otherwise, you risk injury as the result of the unit toppling over or dropping down.



Never connect/disconnect a power plug if your hands are wet

Otherwise, you could receive an electric shock.



Disconnect all cords/cables before moving the unit

Before moving the unit, disconnect the power plug from the outlet, and pull out all cords from external devices.



Before cleaning the unit, disconnect the power plug from the outlet

If the power plug is not removed from the outlet, you risk receiving an electric shock.



Whenever there is a threat of lightning, disconnect the power plug from the outlet

If the power plug is not removed from the outlet, you risk causing malfunction or receiving an electric shock.



Handle the ground terminal carefully

If you remove the screw from the ground terminal, be sure to replace it; don't leave it lying around where it could accidentally be swallowed by small children. When refastening the screw, make that it is firmly fastened, so it won't come loose.



CAUTION

Precautions concerning use of phantom power supply

Always turn the phantom power off when connecting any device other than condenser microphones that require phantom power. You risk causing damage if you mistakenly supply phantom power to dynamic microphones, audio playback devices, or other devices that don't require such power. Be sure to check the specifications of any microphone you intend to use by referring to the manual that came with it.



(This instrument's phantom power:

48 V DC, 14 mA Max)

IMPORTANT NOTES

Power Supply

- Do not connect this unit to same electrical outlet that is being used by an electrical appliance that is controlled by an inverter or a motor (such as a refrigerator, washing machine, microwave oven, or air conditioner). Depending on the way in which the electrical appliance is used, power supply noise may cause this unit to malfunction or may produce audible noise. If it is not practical to use a separate electrical outlet, connect a power supply noise filter between this unit and the electrical outlet.
- The AC adaptor will begin to generate heat after long hours of consecutive use. This is normal, and is not a cause for concern.

Placement

- Using the unit near power amplifiers (or other equipment containing large power transformers) may induce hum. To alleviate the problem, change the orientation of this unit; or move it farther away from the source of interference.
- This unit may interfere with radio and television reception. Do not use this unit in the vicinity of such receivers.
- Noise may be produced if wireless communications devices, such as cell phones, are operated in the vicinity of this unit. Such noise could occur when receiving or initiating a call, or while conversing. Should you experience such problems, you should relocate such wireless devices so they are at a greater distance from this unit, or switch them off.
- When moved from one location to another where the temperature and/or humidity is very different, water droplets (condensation) may form inside the unit. Damage or malfunction may result if you attempt to use the unit in this condition. Therefore, before using the unit, you must allow it to stand for several hours, until the condensation has completely evaporated.
- Depending on the material and temperature of the surface on which you place the unit, its rubber feet may discolor or mar the surface.
- Do not place containers or anything else containing liquid on top of this unit. Also, whenever any liquid has been spilled on the surface of this unit, be sure to promptly wipe it away using a soft, dry cloth.

Maintenance

- Never use benzene, thinners, alcohol or solvents of any kind, to avoid the possibility of discoloration and/or deformation.

Repairs and Data

- Before sending the unit away for repairs, be sure to make a backup of the data stored within it; or you may prefer to write down the needed information. Although we will do our utmost to preserve the data stored in your unit when we carry out repairs, in some cases, such as when the memory section is physically damaged, restoration of the stored content may be impossible. Roland assumes no liability concerning the restoration of any stored content that has been lost.

Additional Precautions

- Any data stored within the unit can be lost as the result of equipment failure, incorrect operation, etc. To protect yourself against the irretrievable loss of data, try to make a habit of creating regular backups of the data you've stored in the unit.
- Roland assumes no liability concerning the restoration of any stored content that has been lost.
- Use a reasonable amount of care when using the unit's buttons, sliders, or other controls; and when using its jacks and connectors. Rough handling can lead to malfunctions.
- Never strike or apply strong pressure to the display.
- When disconnecting all cables, grasp the connector itself—never pull on the cable. This way you will avoid causing shorts, or damage to the cable's internal elements.
- To avoid disturbing others nearby, try to keep the unit's volume at reasonable levels.
- This unit allows you to switch images at high speed. For some people, viewing such images can cause headache, nausea, or other discomfort. Do not use this unit to create video that might cause these types of health problems. Roland Corporation will accept no responsibility for any such health problems that may occur in yourself or in viewers.
- Do not use connection cables that contain a built-in resistor.

Using External Memories

- Please observe the following precautions when handling external memory devices. Also, make sure to carefully observe all the precautions that were supplied with the external memory device.
 - Do not remove the device while reading/writing is in progress.
 - To prevent damage from static electricity, discharge all static electricity from your person before handling the device.

Intellectual Property Right

- It is forbidden by law to make an audio recording, video recording, copy or revision of a third party's copyrighted work (musical work, video work, broadcast, live performance, or other work), whether in whole or in part, and distribute, sell, lease, perform or broadcast it without the permission of the copyright owner.
- Do not use this product for purposes that could infringe on a copyright held by a third party. We assume no responsibility whatsoever with regard to any infringements of third-party copyrights arising through your use of this product.
- This product can be used to record or duplicate audio or visual material without being limited by certain technological copy-protection measures. This is due to the fact that this product is intended to be used for the purpose of producing original music or video material, and is therefore designed so that material that does not infringe copyrights belonging to others (for example, your own original works) can be recorded or duplicated freely.
- This product contains eParts integrated software platform of eSOL Co.,Ltd. eParts is a trademark of eSOL Co., Ltd. in Japan.
- Roland is an either registered trademark or trademark of Roland Corporation in the United States and/or other countries.
- Company names and product names appearing in this document are registered trademarks or trademarks of their respective owners.
- Fugue © 1999-2017 Kyoto Software Research, Inc. All rights reserved.



Panel Descriptions

Top Panel/Side Panel

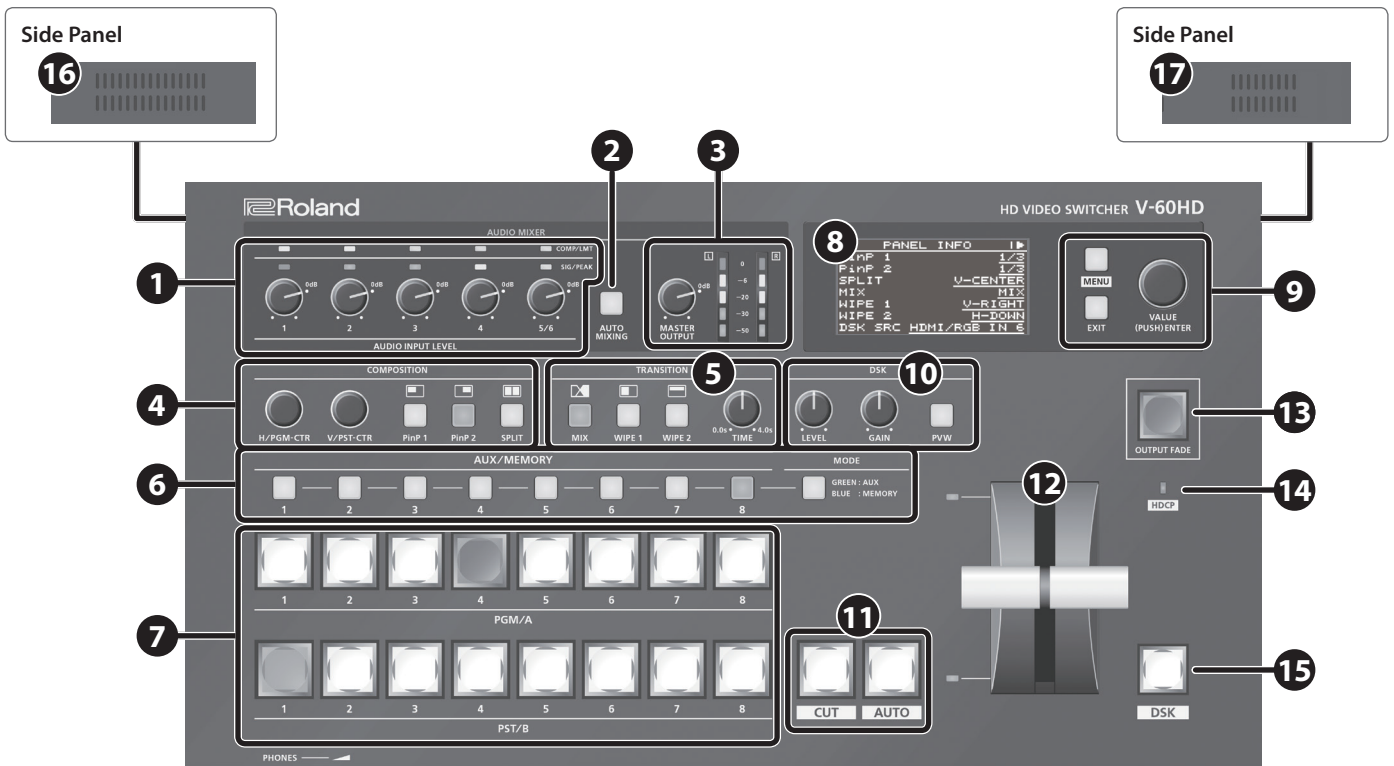

NO.	Name	Explanation	Page
1	COMP/LMT indicators	When the compressor is turned on for AUDIO IN 1–5/6, this lights up when compression is applied.	p. 26
	AUDIO INPUT LEVEL [1]–[5/6] knobs	These adjust the volume level for AUDIO IN 1–5/6.	p. 25
	SIG/PEAK indicators	This lights up when input via AUDIO IN 1–5/6 is detected, and when the volume level is too high.	p. 24
2	[AUTO MIXING] button	This switches the Auto Mixing feature on and off. When the feature is turned on, the [AUTO MIXING] button lights up.	p. 28
3	[MASTER OUTPUT] knob	This adjusts the volume level for master out.	p. 25
	MASTER OUTPUT level meter	This displays the volume level for master out.	
4	[PinP 1] button [PinP 2] button [SPLIT] button	This switches PinP or split video composition on and off. When the feature is turned on, the button lights up.	p. 21 p. 22
	[H/PGM-CTR] knob	PinP: This adjusts the horizontal display position of the inset screen. Split: This adjusts the vertical and horizontal position of the video displayed above or on the left.	
	[V/PST-CTR] knob	PinP: This adjusts the vertical display position of the inset screen. Split: This adjusts the vertical and horizontal position of the video displayed below or on the right.	
5	[MIX] button [WIPE 1] button [WIPE 2] button	These select video transition effects. The selected button lights up.	p. 16 p. 42
	[TIME] knob	This sets the video transition time.	p. 17

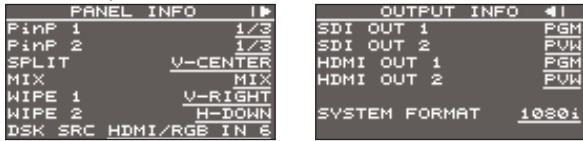
NO.	Name	Explanation	Page				
	[MODE] button	This switches the functioning of the AUX/MEMORY buttons.	p. 18 p. 31				
6	AUX/MEMORY [1]–[8] buttons	<p>When the [MODE] button is lighted in green</p> <p>The buttons function as AUX-bus selection buttons. They select the video (channel 1–8) to send to the AUX bus. The selected button lights up in red.</p> <p>The respective buttons also function as indicators showing the input status of the video.</p>	p. 18				
		<p>When the [MODE] button is lighted in blue</p> <p>The buttons function as preset-memory selection buttons. These save video and audio settings, the state of the operation panel, and other current settings, and call up settings saved in memory.</p>	p. 31				
7	Cross-point [1]–[8] buttons	<p>These select the video to output.</p> <table border="1"> <tr> <td>PGM/A bus end</td> <td>These select the video (channel 1–8) to send to the PGM/A bus. The video on the PGM/A bus becomes the final video output. The selected button lights up in red.</td> </tr> <tr> <td>PST/B bus end</td> <td>These select the video (channel 1–8) to send to the PST/B bus. The video on the PST/B bus is the preset video (the video to be output next). The selected button lights up in green. * While video compositing is in progress, the button lights up in red.</td> </tr> </table> <p>* The system functions as just described when the operation mode is set to "PGM/PST mode." Operation differs when in the A/B mode.</p>	PGM/A bus end	These select the video (channel 1–8) to send to the PGM/A bus. The video on the PGM/A bus becomes the final video output. The selected button lights up in red.	PST/B bus end	These select the video (channel 1–8) to send to the PST/B bus. The video on the PST/B bus is the preset video (the video to be output next). The selected button lights up in green. * While video compositing is in progress, the button lights up in red.	p. 16
		PGM/A bus end	These select the video (channel 1–8) to send to the PGM/A bus. The video on the PGM/A bus becomes the final video output. The selected button lights up in red.				
PST/B bus end	These select the video (channel 1–8) to send to the PST/B bus. The video on the PST/B bus is the preset video (the video to be output next). The selected button lights up in green. * While video compositing is in progress, the button lights up in red.						
8	Built-in display	<p>This displays current information about the V-60HD. There are the two types—PANEL INFO and OUTPUT INFO—and you use the [VALUE] knob to switch between them.</p> 	—				
9	[MENU] button	This switches between displaying or hiding the menu. The menu appears on the unit's built-in display and on the multi-view monitor (p. 10) connected to the MULTI-VIEW connector.	p. 11				
	[EXIT] knob	This returns you to the menu one level higher.					
	[VALUE] knob	Turning: This selects a menu item or changes a setting value. Pressing: This accepts the selected menu item or applies changes to a setting. It also executes operations.					
10	[LEVEL] knob	During DSK compositing, this adjusts the amount of keying (transparency).	p. 23				
	[GAIN] knob	During DSK compositing, this adjusts the degree of edge blur (the semi-transmissive region) for keying.					
	[PVW] button	When this is on (lighted), it makes the DSK compositing results the preview output.					
11	[CUT] button [AUTO] button	These make the preset video (the video to output next) the final output.	p. 17				
12	Video fader	This manually makes the preset video (the video to be output next) the final output.	p. 16				
	Transition indicator	The indicator for the final-output bus end lights up.					
13	[OUTPUT FADE] button	This performs a fade-in or fade-out for the final output video. This flashes or lights up during a fade or fade-out.	p. 20				
14	HDCP indicator	This lights up, flashes, or goes dark according to the V-60HD's "HDCP" setting and the connected status of HDCP-compatible equipment.	p. 15				
15	[DSK] button	This switches DSK composition on or off. When on, the [DSK] button lights up.	p. 23				
16	Cooling-fan exhaust port	These expel internal heat to keep temperatures inside the V-60HD cool.	—				
17	Cooling-fan intake port	<p>NOTE</p> <p>Never obstruct the cooling-fan intake and exhaust ports. Obstructing the intake and exhaust ports might result in a temperature rise inside the V-60HD and lead to malfunction due to heat.</p>					

Rear Panel/Front Panel (Connecting Your Equipment)

- * To prevent malfunction and equipment failure, always turn down the volume, and turn off all the units before making any connections.
- * Be sure to use cables and adaptor plugs with the proper connectors matching those of the other devices you are using.

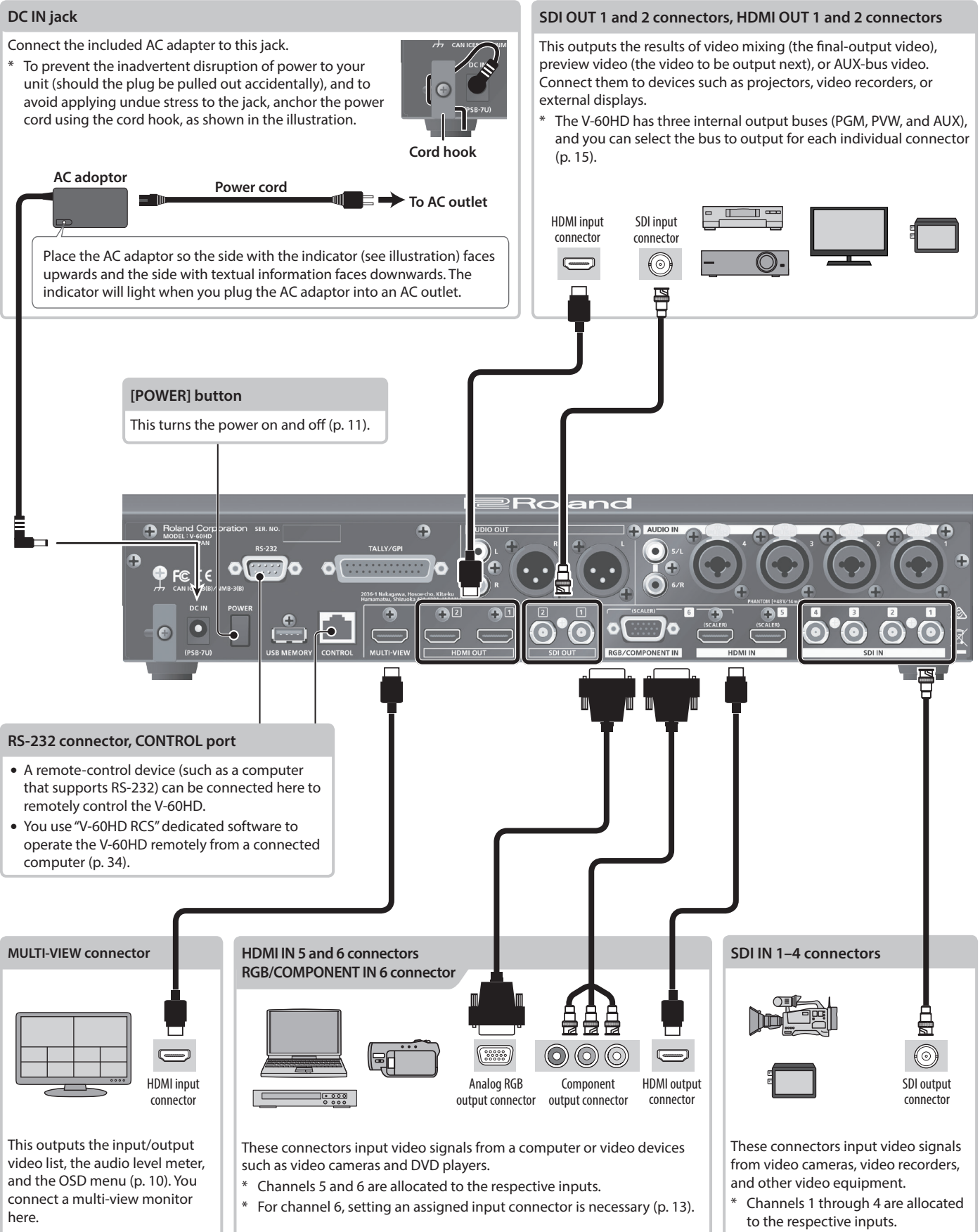

AUDIO OUT connectors/jacks (XLR and RCA)

These output the results of audio mixing (master out). Connect them to an audio recording deck, amplifier, speakers, or other such equipment.

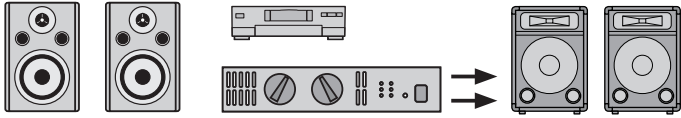

* You can also output just AUX-bus audio from the AUDIO OUT connectors and jacks (XLR and RCA) and the PHONES jack (p. 25).

AUDIO IN 5/6 jacks

These jacks input audio signals from video decks, CD players, and other such audio equipment.



AUDIO IN 1-4 jacks (XLR/TRS)

These jacks input audio signals from microphones, audio mixers, and other such audio equipment.

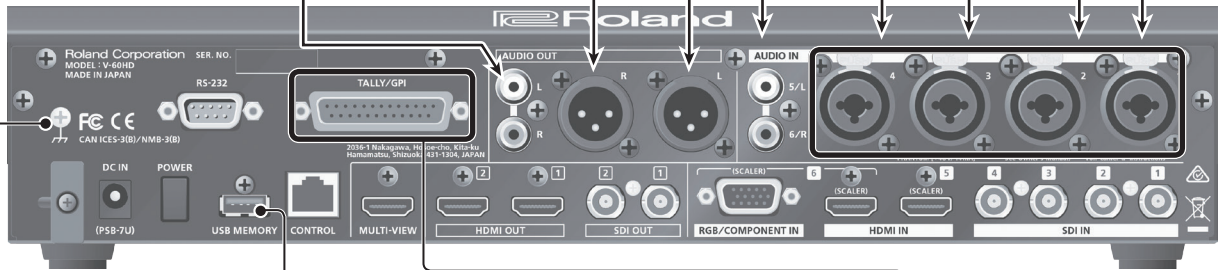
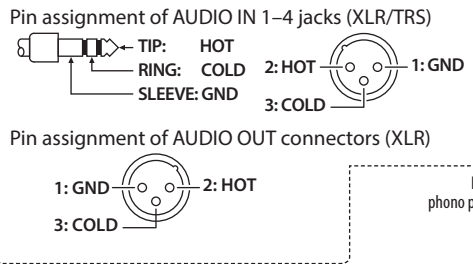

Grounding terminal
Connect this to an external earth or ground.
* Connect this if necessary.

USB MEMORY port
Connect a USB flash drive to this port. You use it when importing still images (p. 19) or when saving or loading settings for the unit (p. 32).
* When using a USB flash drive for the first time, you must format it using the V-60HD.
* Never turn off the power or remove the USB flash drive while the USB flash drive is being accessed.

TALLY/GPI connector
Connect devices provided with a tally-light feature or with control-signal output functionality to this connector.

PHONES jack
Connect headphones to this jack.

[PHONES] knob
This adjusts the volume level for headphones.

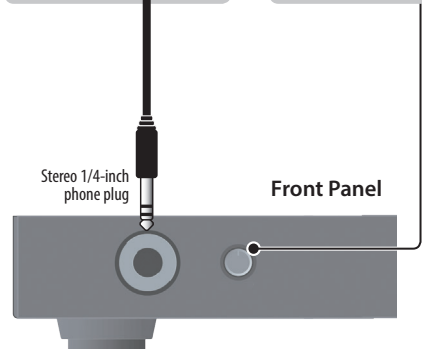



Using Phantom Power
You can supply phantom power (+48 V) from the AUDIO IN 1 through 4 jacks. Turn on phantom power when you're using a condenser microphone that requires phantom power.
Select the [MENU] button → "AUDIO INPUT" → "AUDIO IN 1" through "AUDIO IN 4" → set "PHANTOM +48V" to "ON."
NOTE
Always turn the phantom power off when connecting any device other than condenser microphones that require phantom power. You risk causing damage if you mistakenly supply phantom power to dynamic microphones, audio playback devices, or other devices that don't require such power. Be sure to check the specifications of any microphone you intend to use by referring to the manual that came with it.
(This instrument's phantom power: 48 V DC, 14 mA Max)

Multi-view Monitor Display

A list of input/output video streams, the audio level meter, and the OSD menu are displayed on the multi-view monitor connected to the MULTI-VIEW connector.

* Pressing the [MENU] button displays the OSD menu. Its content is the same as the menu shown on the built-in display (p. 11). Label names, tally borders, and the audio level meter are hidden while the OSD menu is displayed.



No	Name	Explanation
1	PVW (preview) section	This displays the preset video (the video to be output next). 
2	PGM (program) section	This displays the final output video. 
3	Channel section	This displays video input via channels 1–6 and still images assigned to channels 7 and 8. The final video output and preset video (the video to be output next) are displayed with tally borders. Channel information  1 When the Audio Follow feature is on (p. 29), the "A.F" symbol is displayed. 2 When video or a still image is being sent to the AUX bus (p. 18), the "AUX" symbol is displayed. 3 This displays a level meter for SDI or HDMI audio. * The indicators for the level meter are the same as for master out.

MEMO

You can change the settings so that the label names, tally borders, audio level meter, OSD menu, and other such elements displayed on the multi-view monitor are always hidden.

Select the [MENU] button → "SYSTEM," then set the menu items shown below to "OFF:"

- MULTI-VIEW LABEL (label names)
- MULTI-VIEW TALLY (tally borders and AUX symbol)
- AUDIO LEVEL METER (audio level meter and A.F symbol)
- ON SCREEN MENU (OSD menu)

Basic Operations

Turning the Power On and Off

- * Before turning the unit on/off, always be sure to turn the volume down. Even with the volume turned down, you might hear some sound when switching the unit on/off. However, this is normal and does not indicate a malfunction.

Turning the power on

- * If still images are saved on the unit (p. 18), startup takes longer time according to image size and the number of still images saved.

1. Make sure all devices are turned off.
2. Press the [POWER] button to turn on the power.

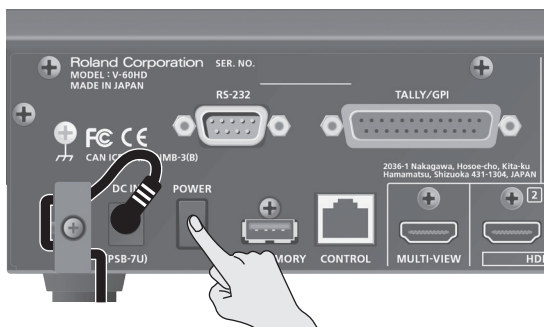

3. Turn on the power of the source devices.
Turn on the power of the source devices that are connected to the V-60HD's input connectors, such as video cameras.
4. Turn on the power of the output devices.
Turn on the power of the devices that are connected to the V-60HD's output connectors, such as projectors.

Turning the power off

1. Turn off the power in the order of output devices → source devices.
2. Press the V-60HD's [POWER] button to turn off the power.

About the Auto Off function

The power to the V-60HD turns off automatically when all of the following states persist for 240 minutes (Auto Off function).

- No operation performed on the V-60HD
- No audio or video input
- No equipment is connected to the HDMI OUT connectors

If you do not want the power to be turned off automatically, disengage the Auto Off function. Select the [MENU] button → "SYSTEM" → set "AUTO OFF" to "OFF."

NOTE

- Any settings that you are in the process of editing will be lost when the power is turned off. If you have any settings that you want to keep, you should save them beforehand.
- To restore power, turn the power on again.

Operating the Menu

- This makes menus appear on the built-in display for making settings for video and audio or for the V-60HD itself.
- * The OSD menu is similarly also displayed on the multi-view monitor connected to the MULTI-VIEW connector (p. 10).

1. Press the [MENU] button to display the menu.

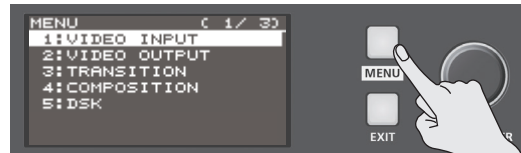

The [MENU] button is lit, and the menu categories are displayed.

2. Turn the [VALUE] knob to select a category, and press the [VALUE] knob to confirm.

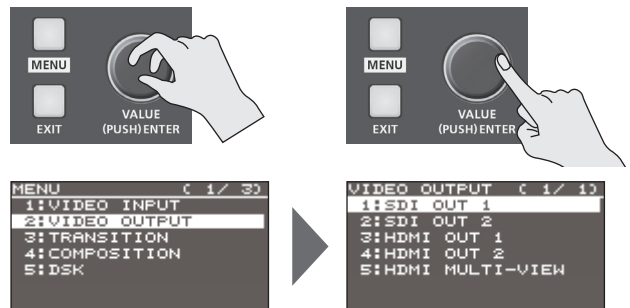

The menu for the selected category is displayed.

3. Turn the [VALUE] knob to select a menu item, then press the [VALUE] dial to confirm.

The cursor moves to the setting value.

- If the menu item is located at a deeper level, repeat step 3.
- Pressing the [EXIT] button moves you back one level higher.

4. Turn the [VALUE] knob to change the value of the setting.

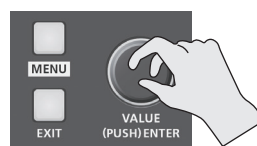

- By turning the [VALUE] knob while pressing it, you can change the value more greatly.
- Pressing and holding the [VALUE] knob returns the current menu item you're setting to its default value.
- To execute an operation, press the [VALUE] knob.

5. Press the [VALUE] knob to apply the setting.

The cursor returns to the menu item.

6. Press the [MENU] button to quit the menu.

MEMO

For details on the menu items, refer to the "Reference Manual" (PDF) which you can download from the Roland website.

<https://proav.roland.com/>

Video Input/Output Settings

Setting the Video Input/Output Format

Set parameters for the input/output format to match the connected equipment.

Setting the System Format

On the V-60HD, the input/output format is determined according to the system format. You set the input/output format to match the connected equipment.

System format	Input format (*1)	Output format (*2)
	SDI IN 1-4 connectors	SDI OUT 1 and 2 connectors HDMI OUT 1 and 2 connectors
1080p	1080p, 1080i	1080p
1080i	1080p, 1080i	1080i
720p	720p	720p

(*1) **Input formats for channels 5 and 6**

You can specify separate individual input formats for the channel 5 and 6 input connectors (HDMI IN 5, HDMI IN 6, and RGB/COMPONENT 6), regardless of the system format.

For details, refer to "Setting the Input Formats for Channels 5 and 6" on this page.

(*2) The output format at the MULTI-VIEW connector is fixed at "1080p" and cannot be changed.

1. Select the [MENU] button → "SYSTEM" → "SYSTEM FORMAT."

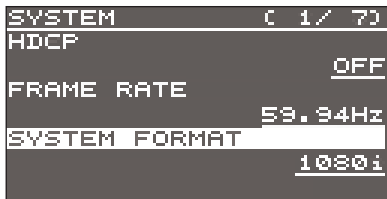

2. Use the [VALUE] knob to set the system format to "1080p," "1080i," or "720p."

3. Press the [VALUE] knob to apply the setting.

4. Press the [MENU] button to quit the menu.

Internal processing

The V-60HD's internal processing is progressive. Interlaced input video is automatically converted to a progressive signal.

The picture might appear jagged at this time, or the picture in a PinP inset screen or on the multi-view monitor might waver.

This is due to progressive conversion, and is not a malfunction.

About frame rates

Frame rates that can be input are "59.94 Hz" and "50 Hz."

Inputting video at a frame rate other than these might result in no output or dropped frames.

To change the frame rate, press the [MENU] button → "SYSTEM" → "FRAME RATE."

Setting the Input Formats for Channels 5 and 6

By factory default, the EDID assignment for channels 5 and 6 is "INTERNAL" (set so that EDID values of all inputtable formats are sent).

To specify an input format of your choice, change the setting of the EDID information being sent so that it matches the incoming video signal.

MEMO

EDID information is not sent during component signal input.

1. Channel 5

Select the [MENU] button → "VIDEO INPUT" → "HDMI IN 5" → "EDID."

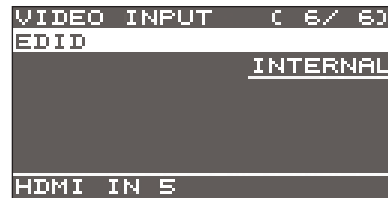

Channel 6

Select the [MENU] button → "VIDEO INPUT" → "HDMI/RGB IN 6" → "EDID."

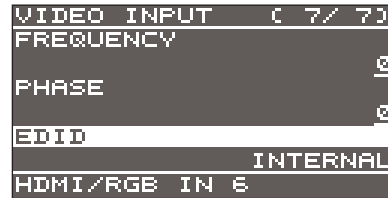

* The settings on the HDMI/RGB IN 6 menu change in tandem with the assignment made using "INPUT 6 ASSIGN" (p. 13). You can make separate individual settings for the respective menu items for the HDMI IN 6 connector and the RGB/COMPONENT IN 6 connector.

2. Use the [VALUE] knob to set the input format (the EDID information to send).

Value			
INTERNAL (EDID information for all inputtable formats is sent.)			
800 x 600	1024 x 768	1280 x 800	1280 x 1024
1366 x 768	1400 x 1050	1600 x 1200	1920 x 1200
720p (*1)	1080i (*1)	1080p (*1)	

(*1) For channel 6, this setting can be made only when "INPUT 6 ASSIGN" (p. 13) is set to "HDMI."

3. Press the [VALUE] knob to apply the setting.

4. Press the [MENU] button to quit the menu.

Assigning a Video Source to Channel 6

You can assign a video source at the HDMI IN 6 connector or the RGB/COMPONENT IN 6 connector to channel 6.

You change the setting to match the connected source device.

* By factory default, the setting is for the HDMI IN 6 connector.

1. Select the [MENU] button → “VIDEO INPUT” → “HDMI/RGB IN 6” → “INPUT 6 ASSIGN.”

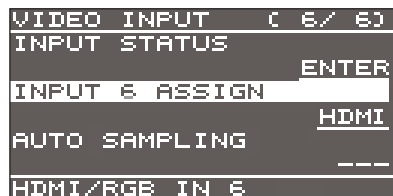

2. Use the [VALUE] knob to specify the input connector to assign to channel 6.

Value	Explanation
HDMI	Video is input via the HDMI IN 6 connector.
RGB/COMPONENT	Video is input via the RGB/COMPONENT IN 6 connector.

3. Press the [VALUE] knob to apply the setting.
4. Press the [MENU] button to quit the menu.

Adjusting Output Video

You can adjust the output video to match the equipment receiving the output from the V-60HD.

MEMO

You can output a test pattern, useful for adjusting the image quality of a display. You use the [MENU] button → “SYSTEM” → “TEST PATTERN” to specify the test pattern.

1. Select the [MENU] button → “VIDEO OUTPUT” → the output video.

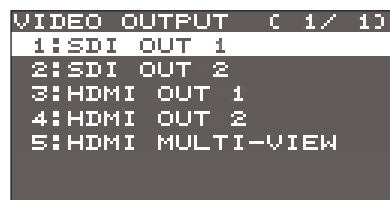

A menu for the selected output video appears.

2. Select a menu item, then use the [VALUE] knob to adjust the output video.

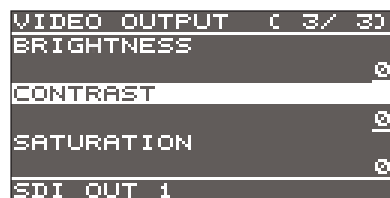

SDI OUT 1 and 2: SDI OUT 1 and 2 connectors

Menu item	Explanation
3G-SDI MAPPING	This sets the mapping structure for 3G-SDI output.
H FLIP	Setting this to “ON” flips the output video horizontally.
BRIGHTNESS	This adjusts the brightness.
CONTRAST	This adjusts the contrast.
SATURATION	This adjusts the saturation.

HDMI OUT 1 and 2: HDMI OUT 1 and 2 connectors HDMI MULTI-VIEW: MULTI-VIEW connector

Menu item	Explanation
COLOR SPACE	This sets the color space (system for representing colors in video).
DVI-D/HDMI SIGNAL	This sets the output mode for HDMI output.
H FLIP (*1)	Setting this to “ON” flips the output video horizontally.
BRIGHTNESS	This adjusts the brightness.
CONTRAST	This adjusts the contrast.
SATURATION	This adjusts the saturation.
RED	This adjusts the red level.
GREEN	This adjusts the green level.
BLUE	This adjusts the blue level.

(*1) HDMI OUT 1 and 2 only

3. Press the [VALUE] knob to apply the setting.
4. Press the [MENU] button to quit the menu.

Adjusting the Input Video

This adjusts the image quality of the video input via the respective connectors. For HDMI IN and RGB/COMPONENT IN connectors, you can also adjust the scaling.

1. Select the [MENU] button → “VIDEO INPUT” → the input video.

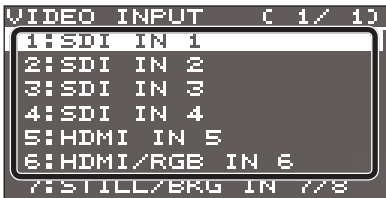

A menu for the selected input video appears.

2. Select a menu item, then use the [VALUE] knob to adjust the input video.

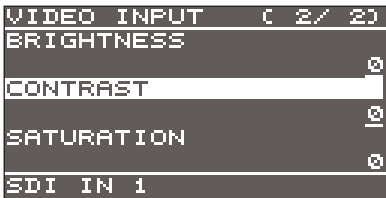

SDI IN 1–4: SDI IN 1–4 connectors

Menu item	Explanation
H FLIP	Setting this to “ON” flips the output video horizontally.
BRIGHTNESS	This adjusts the brightness.
CONTRAST	This adjusts the contrast.
SATURATION	This adjusts the saturation.

HDMI IN 5: HDMI IN 5 connector

Menu item	Explanation
FLICKER FILTER	Setting this to “ON” reduces flicker.
ZOOM	This adjusts the zoom ratio.
SCALING TYPE	This sets the scaling type.
MANUAL SIZE H (*1)	This adjusts the horizontal size.
MANUAL SIZE V (*1)	This adjusts the vertical size.
POSITION H	This adjusts the display position in the horizontal direction.
POSITION V	This adjusts the display position in the vertical direction.
H FLIP	Setting this to “ON” flips the output video horizontally.
BRIGHTNESS	This adjusts the brightness.
CONTRAST	This adjusts the contrast.
SATURATION	This adjusts the saturation.
RED	This adjusts the red level.
GREEN	This adjusts the green level.
BLUE	This adjusts the blue level.
EDID	This sets the input format (EDID) for the HDMI IN 5 connector (p. 12).

(*1) This is available when “SCALING TYPE” is set to “MANUAL.”

HDMI/RGB IN 6: HDMI IN 6 connector (*2) RGB/COMPONENT IN 6 connector (*2)

Menu item	Explanation
AUTO SAMPLING (*3)	This automatically adjusts the image quality. * Depending on the video, adjusting the image quality might not be possible.
FLICKER FILTER	Setting this to “ON” reduces flicker.
ZOOM	This adjusts the zoom ratio.
SCALING TYPE	This sets the scaling type.
MANUAL SIZE H (*4)	This adjusts the horizontal size.
MANUAL SIZE V (*4)	This adjusts the vertical size.
POSITION H	This adjusts the display position in the horizontal direction.
POSITION V	This adjusts the display position in the vertical direction.
H FLIP	Setting this to “ON” flips the output video horizontally.
BRIGHTNESS	This adjusts the brightness.
CONTRAST	This adjusts the contrast.
SATURATION	This adjusts the saturation.
RED	This adjusts the red level.
GREEN	This adjusts the green level.
BLUE	This adjusts the blue level.
FREQUENCY (*3)	This adjusts the input frequency.
PHASE (*3)	This adjusts the phase.
EDID	This sets the input format (EDID) of the HDMI IN 6 connector or RGB/COMPONENT IN 6 connector (p. 12).

(*2) The settings on the HDMI/RGB IN 6 menu change in tandem with the assignment made using “INPUT 6 ASSIGN” (p. 13). You can make separate individual settings for the respective menu items for the HDMI IN 6 connector and the RGB/COMPONENT IN 6 connector.

(*3) This is effective when “INPUT 6 ASSIGN” (p. 13) is set to “RGB/COMPONENT.”

(*4) This is available when “SCALING TYPE” is set to “MANUAL.”

3. Press the [VALUE] knob to apply the setting.
4. Press the [MENU] button to quit the menu.

Changing Output Bus Assignments

The V-60HD has three internal output buses (PGM, PVW, and AUX). You can select which buses to output via the SDI OUT and HDMI OUT connectors.

1. Select the [MENU] button → “VIDEO OUTPUT” → “SDI OUT 1,” “SDI OUT 2,” “HDMI OUT 1,” or “HDMI OUT 2” → “OUTPUT ASSIGN.”

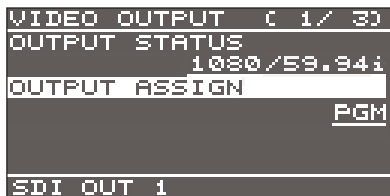

2. Use the [VALUE] knob to select “PGM,” “PVW,” or “AUX” and set the assigned output bus.
3. Press the [VALUE] knob to apply the setting.
4. Press the [MENU] button to quit the menu.

MEMO

- For details about video transitions on the PGM/A bus and PST/B bus, refer to “Switching Using the PGM/PST Mode” (p. 16) and “Switching in the A/B Mode” (p. 17).
- For details about video transitions on the AUX bus, refer to “Switching AUX Output” (p. 18).

About audio outputs assigned to output buses

Changing an output bus assignment makes the output audio also change in tandem, according to the assigned bus.

Output bus assignment	Output audio
PGM, PVW	This groups together all input audio and outputs it (master out).
AUX	This outputs only the audio on the AUX bus.

* The audio of the MULTI-VIEW connector is fixed at master out and cannot be changed.

Inputting Copyright-protected (HDCP) Video

To input copyright-protected (HDCP) video from a Blu-ray Disc player or the like, follow the steps described below to change the “HDCP” setting.

* The V-60HD must be connected to an HDCP compatible display for HDCP protected video to be connected.

What's HDCP?

HDCP is copyright-protection technology that prevents unlawful copying of content by encoding the path when sending digital signals from a video playback device to a display monitor or other display equipment.

1. Select the [MENU] button → “SYSTEM” → “HDCP.”

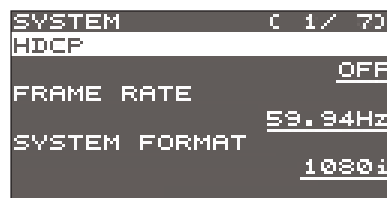

2. Use the [VALUE] knob to set this to “ON.”

Value	Explanation
ON	Copyright-protected (HDCP) video can be input. HDCP is also added to the video that is output.
OFF	Copyright-protected (HDCP) video cannot be input.

3. Press the [VALUE] knob to apply the setting.
4. Press the [MENU] button to quit the menu.

Output from connectors

When “HDCP” is set to “ON,” video is output only from the HDMI OUT and MULTI-VIEW connectors.

No video is output via the SDI OUT connectors.

Operation of the HDCP indicator

The HDCP indicator operates as follows, regardless of input.

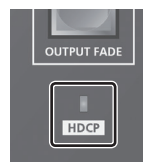

Indicator	“HDCP” setting	Connection status
Lighted	ON	An HDCP-compatible device is connected to the HDMI OUT or MULTI-VIEW connector.
Flashing	ON	No HDCP-compatible device is connected to the HDMI OUT and MULTI-VIEW connectors. Alternatively, a device that does not support HDCP is connected.
Dark	OFF	—

Video Operations

Switching the Video

This switches the video that is input into the V-60HD and performs final output.

About the Operation Mode for Video Transitions

There are two operation modes for switching the video on the PGM/A bus and PST/B bus: the "PGM/PST mode" and the "A/B mode." By factory default, the operation mode is set to the PGM/PST mode.

PGM/PST mode

The video on the PGM/A bus is always the final output. The video on the PST/B bus is preset video (the video to be output next). Operating the video fader or the [CUT] or [AUTO] button makes the final video output and the preset video change places.

A/B mode

When the video fader is operated, the video at the bus position toward which the video fader is flipped always becomes the final output.

When the [CUT] or [AUTO] button is operated, the video on the PGM/A bus and the video on the PST/B bus become the final output in alternation.

MEMO

Video on the AUX bus is switched by operating the AUX/MEMORY buttons.
For details, refer to "Switching AUX Output" (p. 18).

Setting the operation mode

1. Select the [MENU] button → "SYSTEM" → "PANEL OPERATION."

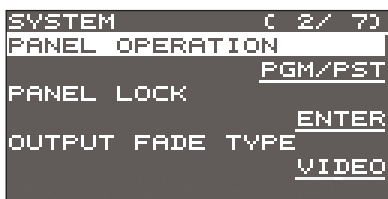

2. Use the [VALUE] knob to select "PGM/PST" or "A/B" and set the operation mode.
3. Press the [VALUE] knob to apply the setting.
4. Press the [MENU] button to quit the menu.

Switching Using the PGM/PST Mode

The video on the PGM/A bus is always the final output. You use the PST/B bus to select the preset video (the video to output next) to verify it and then switch the video.

1. Flip the video fader all the way upward or downward.

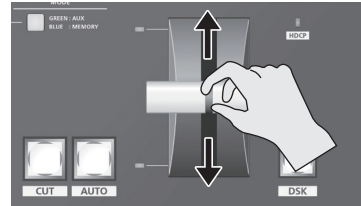

2. Press one of the [WIPE 1], [WIPE 2], or [MIX] button to select the transition effect.

The selected button lights up.



Mix ([MIX] button)

The two pictures are blended together as the video is switched.



Wipe ([WIPE 1] and [WIPE 2] buttons)

In this transition, the original video is broken into by the next video.



MEMO

You can change the transition pattern used for a wipe or mix transition. Select the [MENU] button → "TRANSITION" → "MIX TYPE," "WIPE 1 TYPE," or "WIPE 2 TYPE" to make the setting.

For a list of transition-pattern types, refer to "Transition Effects List" (p. 42).

3. Press a cross-point button for the PST/B bus and select the preset video (the video to be output next).

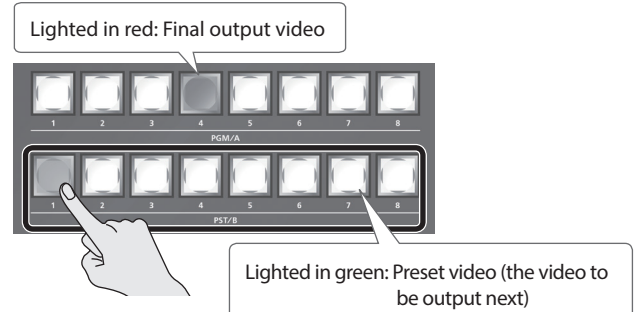

The preset video appears in the PVW section of the multi-view monitor.

MEMO

You use channels 7 and 8 to output a still image or a monochrome picture (background color) (p. 18).

4. Move the video fader in the direction opposite to the direction in step 1.

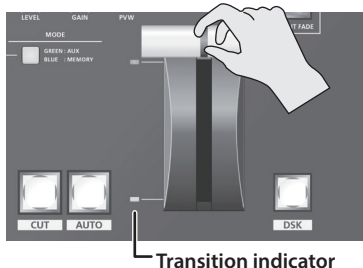

The video changes.

When the video has been switched completely, the cross-point buttons for the PGM/A and PST/B buses change places.

MEMO

- If the transition indicators are both lighted, move the video fader all the way, so that only the indicator for the PGM bus end or the PST bus end is illuminated.
- Using a cross-point button for the PGM/A bus to select a channel directly switches the video using a cut.

Switching in the A/B Mode

The video at the end to which the video fader is flipped is always the final output.

1. Flip the video fader all the way upward or downward.
2. Press a cross-point button at the end to which the video fader is not flipped to select the preset video (the video to output next).

Lighted in red: Final output video
 Lighted in green: Preset video (the video to be output next)

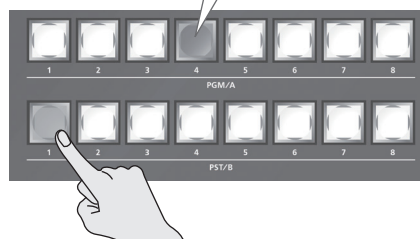

The preset video appears in the PVW section of the multi-view monitor.

MEMO

You use channels 7 and 8 to output a still image or a monochrome picture (background color) (p. 18).

3. Press one of the [WIPE 1], [WIPE 2], or [MIX] button to select the transition effect.

The selected button lights up.

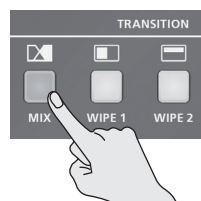

4. Move the video fader in the direction opposite to the direction in step 1.

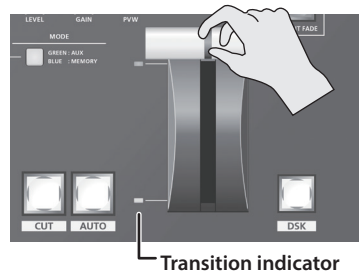

The video changes.

MEMO

- If the transition indicators are both lighted, move the video fader all the way, so that only the indicator for the bus end to be output is illuminated.
- Using a cross-point button for the final-output bus to select a channel directly switches the video using a cut.

Using the [AUTO] or [CUT] button to switch video

You can use the [AUTO] or [CUT] button to switch video, without using the video fader.

* You can perform operations using the [AUTO] and [CUT] buttons both in the PGM/PST mode and in the A/B mode.

1. Use the [TIME] knob to set the video transition time.



* The setting for the video transition time is applied when you use the [AUTO] button to switch video.

2. Press the [AUTO] or [CUT] button at the desired timing for switching the video.

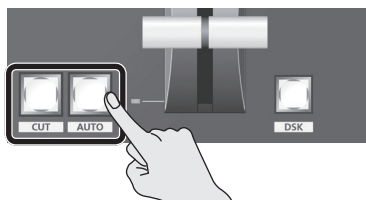

Button	Explanation
[AUTO] button	A transition effect is applied and the video is switched automatically. The [AUTO] button flashes while the video transition is in progress.
[CUT] button	The picture switches instantly.

MEMO

When you use the [AUTO] or [CUT] button to switch video, the actual output might come to differ from the position of the video fader.

Operating the video fader while in this state yields no change in output until the position of the video fader matches the actual output.

Switching AUX Output

You can use button operations to directly select the video to send to the AUX bus.

You can output the video on the AUX bus from SDI OUT connectors or HDMI OUT connectors. To output the AUX bus, you change the bus assignments for the respective connectors to "AUX."

For details, refer to "Changing Output Bus Assignments" (p. 15).

1. Press the [MODE] button to make it light up in green.

Each press of the [MODE] button makes it toggle between lighting up in blue and in green.

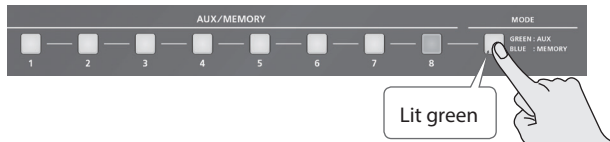

The AUX/MEMORY buttons function as AUX-bus selection buttons. The AUX/MEMORY button currently selected as the video on the AUX bus lights up in red.

2. Press an AUX/MEMORY button to select the AUX-bus video.

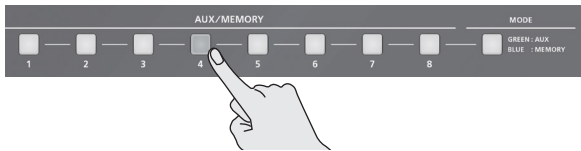

The AUX output is switched.

MEMO

- To adjust the volume level of audio on the AUX bus, select the [MENU] button → "AUDIO OUTPUT" → "AUX" → adjust "AUX LEVEL."
- You use channels 7 and 8 to output a still image or a monochrome picture (background color) (p. 18).
- On the multi-view monitor, the input channel sent to the AUX bus is displayed with an "AUX" symbol.

The colors of lighted AUX/MEMORY buttons

When the [MODE] button is lighted in green, the AUX/MEMORY buttons also function as indicators showing the status of video input.

AUX/MEMORY [1] through [6] Buttons

Button	Input video status
Lighted in green	Valid video is input.
Flashing in green	Video whose format differs from the system format setting is input.
Dark	No video is input.

AUX/MEMORY [7] and [8] Buttons

Button	Input video status
Lighted in green	A still image has been imported.
Dark	No still image has been imported.

MEMO

The AUX/MEMORY button for the currently selected video lights up or flashes in red.

Using Imported Still Images

You can take a still image captured from input video or imported from a USB flash drive, assign it to channel 7 or 8, and output it in the same way as video. You can also use it as a source for DSK compositing (p. 23).

You can save up to two still images in the unit.

- * When still images are saved in the unit, startup takes longer time according to image size and the number of still images saved.

Capturing a Still Image from Input Video

This captures a still image from input video and saves it in the unit.

NOTE

- All video input stops during still-image capture.
- Depending on the format of the input video, completion of still-image capture might take some time.
- Created still images cannot be saved to a USB flash drive.

1. Select the [MENU] button → "CAPTURE IMAGE" → "CAPTURE SOURCE," then use the [VALUE] knob to specify the input video to use for still-image capture.

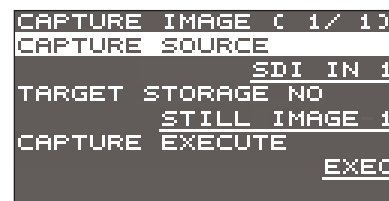

2. Press the [VALUE] knob to apply the setting.

3. Select "TARGET STORAGE NO," then use the [VALUE] knob to select "STILL IMAGE 1" or "STILL IMAGE 2" as the memory destination for saving the still image.

A "*" symbol is displayed for memory where a still image is already saved.

4. Press the [VALUE] knob to apply the setting.

5. Select "CAPTURE EXECUTE."

A confirmation message appears.

If you want to cancel the operation, press the [EXIT] button.

6. Use the [VALUE] knob to select "YES," then press the [VALUE] knob.

Capturing is carried out.

7. Press the [MENU] button to quit the menu.

MEMO

HDCP-applied video on HDMI IN 5 and 6

When you have captured from copyright-protected (HDCP) video, the created still image is treated the same way as HDCP-applied video.

The still image is switched between displayed and hidden by turning HDCP on and off (p. 15).

Note, however, that when HDCP is switched from off to on, the still image is reloaded from where it's saved in memory, and so the still image might take some time to display.

Importing a Still Image from a USB Flash Drive

This imports into the unit a still image saved on a USB flash drive.

Supported still-image formats and resolutions

Still-image file formats that can be imported are as follows.

	Explanation
Format	Bitmap (.bmp), 24-bit color, uncompressed
Resolution	In conformity with system format (p. 12)
File name	No more than 8 single-byte alphanumeric characters * Be sure to append the ".bmp" file extension.

Importing a still image

NOTE

- All video input stops while a still image is being imported from a USB flash drive.
- Large-size still-image files might take some time to import.
- When you're using a USB flash drive for the first time, be sure to format it on the V-60HD (p. 33).
- Depending on the USB flash drive, recognition of the flash drive might take some time.

1. Save the still image in the root directory of the USB flash drive.
2. Connect the USB flash drive containing the saved still image to the USB MEMORY port.
3. Select the [MENU] button → "USB MEMORY" → "LOAD STILL IMAGE."



4. Use the [VALUE] knob to select "STILL IMAGE 1" or "STILL IMAGE 2" as the memory where the still image is saved. A "*" symbol is displayed for memory where a still image is already saved.
5. Press the [VALUE] knob. The USB LOAD screen appears. The names of the files on the USB flash drive are displayed on this screen.
6. Select the still image file you want to import, then press the [VALUE] knob. A confirmation message appears. If you want to cancel the operation, press the [EXIT] button.
7. Use the [VALUE] knob to select "YES," then press the [VALUE] knob. The still image is imported into the unit.
8. Press the [MENU] button to quit the menu.

Assigning Still Images to Channels 7 and 8

This takes a still image that has been captured or imported from a USB flash drive, and assigns it to channel 7 or 8.

1. Select the [MENU] button → "VIDEO INPUT" → "STILL/BKG 7/8" → "INPUT 7 ASSIGN" or "INPUT 8 ASSIGN."

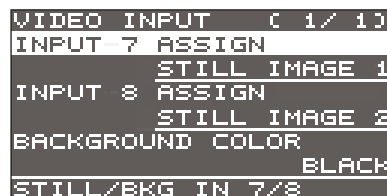

2. Use the [VALUE] knob to select the memory where the still image is saved. A "*" symbol is displayed for memory where a still image is already saved.
3. Press the [VALUE] knob to apply the setting.
4. Press the [MENU] button to quit the menu.

MEMO

Assigning a monochrome picture (background color)

You can also assign a monochrome picture (background color) to channel 7 or 8.

In step 2, set "INPUT 7 ASSIGN" or "INPUT 8 ASSIGN" to "BACKGROUND." Also, use "BACKGROUND COLOR" to specify the background color.

* The background-color setting is shared by channels 7 and 8.

Deleting a Still Image

This deletes a still image saved in the unit.

1. Select the [MENU] button → "SYSTEM" → "DELETE STILL IMAGE."

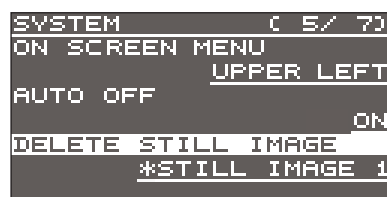

2. Use the [VALUE] knob to select "STILL IMAGE 1" or "STILL IMAGE 2" as the memory you want to delete. A "*" symbol is displayed for memory where a still image is already saved.
3. Press the [VALUE] knob. A confirmation message appears. If you want to cancel the operation, press the [EXIT] button.
4. Use the [VALUE] knob to select "YES," then press the [VALUE] knob. The still image is deleted.
5. Press the [MENU] button to quit the menu.

Applying a Fade to PGM/PVW Output Video (Output Fade)

This performs a fade-out from the output video to a black screen, or a fade-in from a black screen to the output video.

You can insert a black screen into the output video at times where you don't want to output a picture, such as at intervals in presentations or band performances.

MEMO

Fade-ins and fade-outs are applied to the final video output (program output) and the preset video (preview output).

Applying a fade to AUX-bus output is not possible.

1. Press the [OUTPUT FADE] button to perform a fade-out.

During the fade, the [OUTPUT FADE] button flashes.

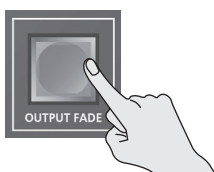

When the fade-out is complete, the [OUTPUT FADE] button lights up.

2. To perform a fade-in, press the [OUTPUT FADE] button again.

When the fade-in is complete, the [OUTPUT FADE] button goes dark.

MEMO

- The length of the fade-in or fade-out time uses the setting for length transition time.
- You can apply a fade-in and fade-out for both video and audio at the same time. [MENU] button → "SYSTEM" → set "OUTPUT FADE TYPE" to "VIDEO & AUDIO."

Video Composition Operations

This composites video. The V-60HD has three built-in types of composition.

Compositing Using Picture-in-Picture (PinP)

This composites video in an inset screen over a background video. This section describes operations when in the PGM/PST mode (p. 16).

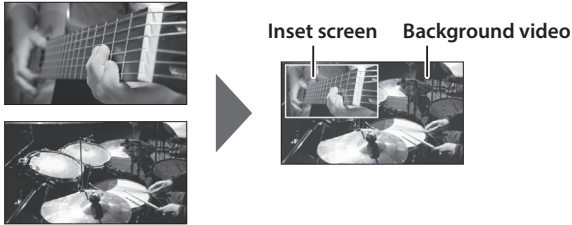

1. Press a cross-point button for the PGM/A bus to select the video you want to make the background video.

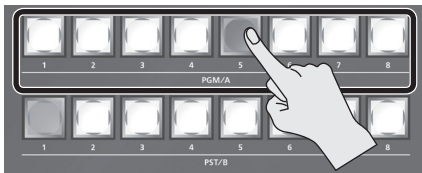

2. Press a cross-point button for the PST/B bus to select the video you want to make the inset screen.

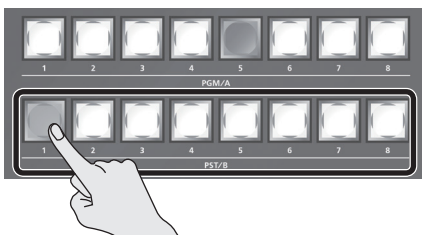

3. Press the [PinP 1] or [PinP 2] button to turn on video compositing (making the button light up).

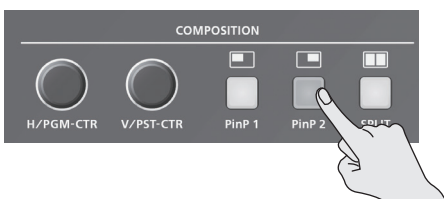

The selected button lights up in green and the inset screen appears in the PVW section of the multi-view monitor, allowing you to check the inset screen's location and size. At this stage, the final output has not yet been changed.

4. Use the [H/PGM-CTR] and [V/PST-CTR] knobs to adjust the display position of the inset screen.

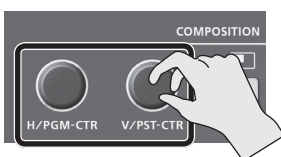

[H/PGM-CTR] knob
This adjusts the inset screen's display position horizontally.

[V/PST-CTR] knob
This adjusts the inset screen's display position vertically.

5. Press the [AUTO] or [CUT] button.

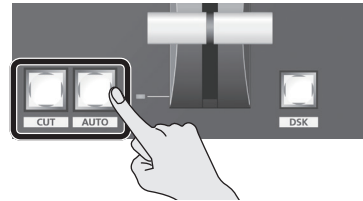

The inset screen is composited onto the background video and the result is sent to final output. The [PinP 1] (or [PinP 2]) button and the cross-point button for the PST/B bus light up in red. Pressing the [AUTO] or [CUT] button a second time makes the inset screen disappear.

MEMO

You can also display or hide the inset screen by operating the video fader.













6. To turn off video composition, press the lighted [PinP 1] or [PinP 2] button.

MEMO

The video transition-time setting is applied as the fade time when you use the [AUTO] button to display or hide the inset screen.

Making detailed settings for the inset screen

You can use the [PinP 1] and [PinP 2] buttons to make settings for the size and location of individual inset screens, and to make setting such as for the width of borders added to the inset screens. Select the [MENU] button → "COMPOSITION" → "PinP 1" or "PinP 2," then make the settings for the menu items shown below.

Menu item	Explanation								
SIZE	This sets the size. For the inset screen, you select a horizontal width of 1/2, 1/3, or 1/4 as the horizontal width of the background video.								
POSITION H	This adjusts the display position in the horizontal direction.								
POSITION V	This adjusts the display position in the vertical direction.								
BORDER COLOR	This specifies the color of the border. Setting this to "SOFT EDGE" blurs the edge.								
BORDER WIDTH	This adjusts the border width.								
SHAPE	This specifies the shape. <table border="1" style="width: 100%; text-align: center;"> <thead> <tr> <th>SQUARE</th> <th>CIRCLE</th> <th>HEART</th> <th>DIAMOND</th> </tr> </thead> <tbody> <tr> <td></td> <td></td> <td></td> <td></td> </tr> </tbody> </table>	SQUARE	CIRCLE	HEART	DIAMOND				
SQUARE	CIRCLE	HEART	DIAMOND						
									
ASPECT	This specifies the aspect ratio.								

Compositing Using Split

This composites two video streams in a split screen. The final output video is displayed above or on the left, and the preset video (the video to be output next) is displayed below or on the right. This section describes operations when in the PGM/PST mode (p. 16).

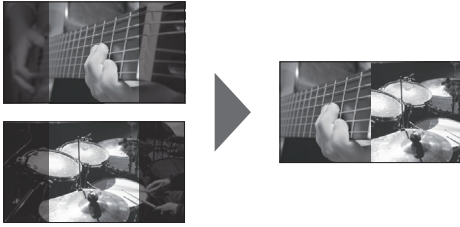

Specifying a split composition pattern

This makes the settings for the split composition pattern to match the video you want to composite.

1. Select the [MENU] button → “COMPOSITION” → “SPLIT” → “PATTERN.”

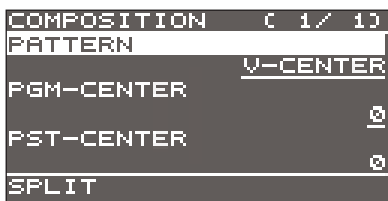

2. Use the [VALUE] knob to specify the split composition pattern.

Value	Explanation	Diagram
V-CENTER	This vertically crops the center section of the video.	
H-CENTER	This horizontally crops the center section of the video.	
V-STRETCH	This stretches the video vertically.	
H-STRETCH	This stretches the video horizontally.	

3. Press the [VALUE] knob to apply the setting.
4. Press the [MENU] button to quit the menu.

Compositing using split

1. Press a cross-point button for the PGM/A bus to select the video you want to display above or on the left.

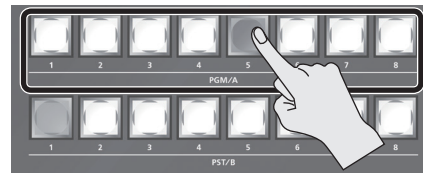

2. Press a cross-point button for the PST/B bus to select the video you want to display below or on the right.

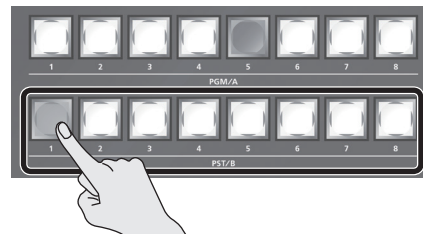

3. Press the [SPLIT] button to turn on video compositing (making the button light up).

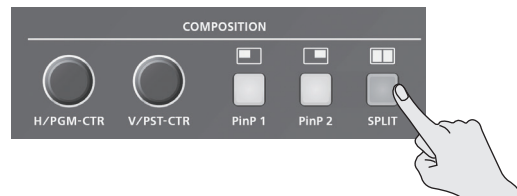

The video you selected in steps 1 and 2 is composited.

* Previewing the results of the split composition in the PVW section of the multi-view monitor is not possible.

4. Use the [H/PGM-CTR] and [V/PST-CTR] knobs to adjust the display position of the video.

* You can carry out adjustment when “V-CENTER” or “H-CENTER” is selected as the split composition pattern.



● When Set to V-CENTER

This adjusts the display position in the horizontal direction.

[H/PGM-CTR] knob: Video on the left

[CV/PST-CTR] knob: Video on the right

● When Set to H-CENTER

This adjusts the display position in the vertical direction.

[H/PGM-CTR] knob: Upper video

[V/PST-CTR] knob: Lower video

5. To turn off video compositing, press the [SPLIT] button a second time.

Compositing Using DSK

This takes video composited upstream using PinP or the like, and performs further downstream compositing with text or images. Using DSK (downstream keying), you can switch the background video while text or images remain displayed.

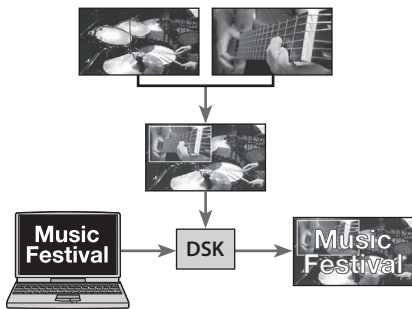

Setting the key type and extraction color

To change the key type and extraction color to match the video you want to composite.

1. Select the [MENU] button → “DSK” → “DSK TYPE.”

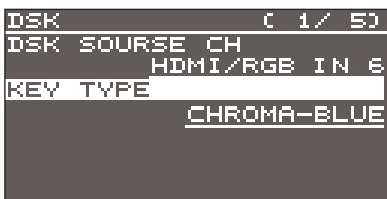

2. Use the [VALUE] knob to specify the key type (extraction color) to use when compositing.

Value	Explanation
LUMINANCE-WHITE	This uses a brightness threshold to make white transparent.
LUMINANCE-BLACK	This uses a brightness threshold to make black transparent.
CHROMA-GREEN	This uses a color threshold to make green transparent.
CHROMA-BLUE	This uses a color threshold to make blue transparent.

3. Press the [VALUE] knob to apply the setting.
4. Press the [MENU] button to quit the menu.

MEMO

When the key type is chroma key (“CHROMA-GREEN” or “CHROMA-BLUE”), you can use the DSK menu to fine-tune the key color.

Menu item	Explanation
HUE WIDTH	This adjusts the hue width (range).
HUE FINE	This adjusts the center position for hue.
SATURATION WIDTH	This adjusts the saturation width (range).
SATURATION FINE	This adjusts the center position for saturation.

Compositing using DSK

1. Input the logo or image.

By factory default, the settings are such that text and image input on channel 6 are used in DSK composition.

When you want to use text or image on another channel, use the [MENU] button → “DSK” → “DSK SOURCE CH” to change the channel.

When you want to composite a still image saved in the unit (p. 18), set this to “STILL/BKG IN 7” or “STILL/BKG IN 8.”

2. Output the background video.

At the PVW section of the multi-view monitor, check the video to be made the background.

3. Press the [PVW] button to turn on the preview output (lighted).

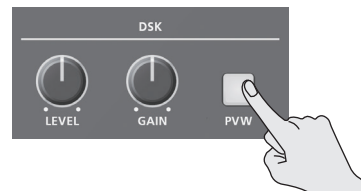

The [PVW] button lights up in green, and a preview of the composition results is displayed in the PVW section of the multi-view monitor.

At this stage, the final output has not yet been changed.

4. Turn the [LEVEL] or [GAIN] knob to adjust the degree of effect applied.



[LEVEL] knob

This adjusts the degree of extraction (transparency) for the key.

[GAIN] knob

This adjusts the degree of edge blur (semi-transmissive region) for the key.

5. Press the [DSK] button to turn on DSK composition (lighted).



The [DSK] button lights up in red, and the text or image is composited and the results are output.

6. To turn off DSK compositing, press the [DSK] button a second time.

The [DSK] button goes dark and the text and images disappear from the output.

MEMO

- The video transition-time setting is applied as the fade time for DSK-composited text and image.
- You can adjust the overall density of the text and images being composited using DSK. Select the [MENU] button → “DSK” → “MIX LEVEL” to adjust it.

Audio Operations

Adjusting the Volume Level

This adjusts the head amp gain, sound position, and volume balance of audio input to the V-60HD.

Adjusting the Head Amp Gain

This adjusts the head amp gain so that the input audio is at a suitable level.

* You can adjust the head amp gain only for AUDIO IN 1 through 4.

1. Adjust the AUDIO INPUT LEVEL knob for the input audio whose head amp gain you want to adjust to a position near "0 dB."



2. Adjust the [MASTER OUTPUT] knob to a position near "0 dB."

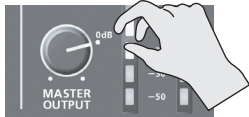

3. Select the [MENU] button → "AUDIO INPUT" → "AUDIO IN 1" through "AUDIO IN 4" → "HEAD AMP GAIN."

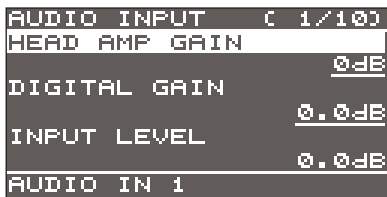

* When adjusting the head amp gain, check to make sure the value of "DIGITAL GAIN" is "0.0 dB."

4. Turn the [VALUE] knob all the way counterclockwise to lower the head amp gain.
5. Slowly turn the [VALUE] knob clockwise to adjust the head amp gain.
Use the [VALUE] knob to gradually raise the head amp gain as you play the actual incoming signal. Boost the head amp gain as high as possible without making the SIG/PEAK indicator light up in red.

MEMO

SIG/PEAK Indicator Readings

Indicator	Status
Red	When input reaches the peak value (0 dB)
Green	When input is detected (-50 dB or higher)

6. Press the [VALUE] knob to apply the setting.
7. Press the [MENU] button to quit the menu.

Adjusting the Sound Position (Pan)

The left-right position of audio is called the sound position (pan). This lets you broaden the sound by moving its sound position farther to the left and right at times such as when you're transmitting feed of a performance using two microphones.

* You can adjust the sound position only for AUDIO IN 1 through 4.

1. Select the [MENU] button → "AUDIO INPUT" → "AUDIO IN 1" through "AUDIO IN 4" → "PAN."

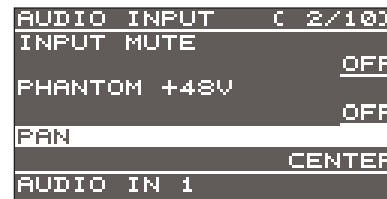

2. Use the [VALUE] knob to adjust the sound position.
3. Press the [VALUE] knob to apply the setting.
4. Press the [MENU] button to quit the menu.

Adjusting the digital gain

On the V-60HD, separately from head amp gain, you can also adjust "digital gain." Whereas head amp gain adjusts analog audio, digital gain adjusts digital audio.

With SDI or HDMI digital audio input, when audio at a high level is input, effect processing can produce distortion.

Using digital gain lets you lower the input level so that effect processing is not affected.

Adjusting the Volume Balance

This adjusts the volume balance of input and the volume level for master out.

1. Adjust the [MASTER OUTPUT] knob to a position near "0 dB."
2. While monitoring the audio via speakers or headphones, adjust the volume balance for the respective inputs.

Raise the volume level of audio you want to make more prominent, for example, an emcee microphone, and lower the volume level for other audio.

When no audio is input, and for audio that is unused, lower the volume level to minimum (-INF).

AUDIO IN 1-5/6

Use the AUDIO INPUT LEVEL knob to adjust the volume level.



SDI IN 1-4, HDMI IN 5 and 6

Select the [MENU] button → "AUDIO INPUT" → "SDI IN 1-4" or "HDMI IN 5-6" → "INPUT LEVEL," then use the [VALUE] knob to adjust the volume level.

3. Use the [MASTER OUTPUT] knob to adjust the volume level for master out.



A level at which indicators "-20" through "-6" light up is appropriate.

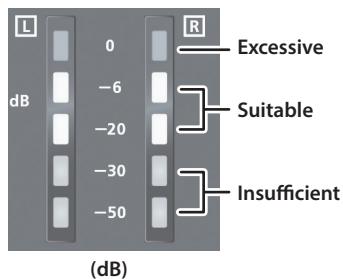

* If the volume level of speaker output is not suitable even after adjustment so that -20 to -6 light up, adjust the volume for the speakers or the amplifier. Using the [MASTER OUTPUT] knob to carry out further adjustment might result in distortion or degradation of sound quality.

MEMO

You can output a test tone, which is useful for adjusting the volume level. Select the [MENU] button → "SYSTEM" → set "TEST TONE" to "-20dB@1kHz," "-10 dB@1kHz," or "0dB@1kHz."

Outputting AUX-bus Audio

You can output just AUX-bus audio from the AUDIO OUT jacks (XLR and RCA) and the PHONES jack.

What's AUX-bus audio?

Video and audio on video input channels selected using the AUX/MEMORY buttons is sent to the AUX bus (p. 18).

When you assign the AUX bus to an audio output connector, only the SDI or HDMI audio sent to the AUX bus is output.

1. Select the [MENU] button → "AUDIO OUTPUT" → "OUTPUT ASSIGN" → "AUDIO OUT (XLR)," "AUDIO OUT (RCA)," or "PHONES OUT."

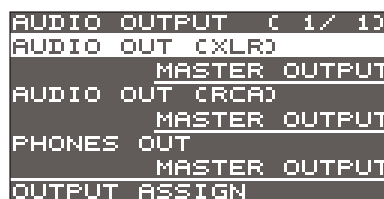

2. Use the [VALUE] knob to set this to "AUX."

Value	Explanation
MASTER OUTPUT	This groups together all input audio and outputs it (master out).
AUX	This outputs only the audio on the AUX bus.

3. Press the [VALUE] knob to apply the setting.
4. Press the [MENU] button to quit the menu.

MEMO

- To adjust the volume level of audio on the AUX bus, select the [MENU] button → "AUDIO OUTPUT" → "AUX" → adjust "AUX LEVEL"
- For the SDI OUT and HDMI OUT connectors, changing the assigned video bus makes the output audio also change in tandem with it.

For details, refer to "Changing Output Bus Assignments" (p. 15).

* The audio of the MULTI-VIEW connector is fixed at master out and cannot be changed.

Applying Effects to Audio

You can apply effects and adjust the sound quality.

Applying Effects to Input Audio

This applies effects and adjusts the sound quality for AUDIO IN, SDI IN, and HDMI IN audio.

1. Select the [MENU] button → "AUDIO INPUT" → the input audio.

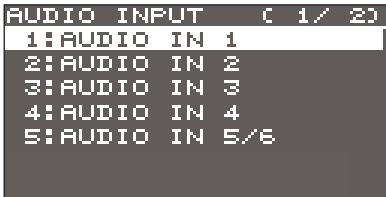

2. Select an effect menu item, then use the [VALUE] knob to adjust it.

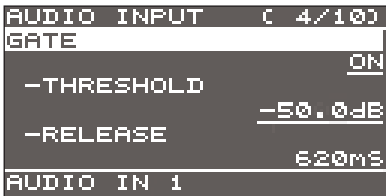

* For more information about effects, refer to the following section.

3. Press the [VALUE] knob to apply the setting.
4. Press the [MENU] button to quit the menu.

High-pass filter (HPF 75Hz)

This cuts off unneeded low-band audio. The cutoff frequency is 75 Hz.

Menu item	Explanation
HPF 75Hz	This sets the high-pass filter on or off.

Delay (DELAY)

This outputs audio with a delay. Delaying audio output lets you align the output timing of video and audio.

Menu item	Explanation
DELAY	This adjusts the delay time for input audio.

Gate (GATE)

This mutes audio that is below a specified level.

Menu item	Explanation
GATE	This sets gate on or off.
THRESHOLD	This sets the level used as the threshold for removing audio. Audio below the level set here is removed.
RELEASE	This adjusts the length of time until the audio is fully attenuated after audio falls below the threshold.

Compressor (COMP/LMT)

This compresses audio that exceeds a specified level.

Menu item	Explanation
COMP/LMT	This sets the compressor on or off.
THRESHOLD	This sets the level used as the threshold at which the compressor is applied. Compression is applied to audio that exceeds the threshold.
RATIO	This species the degree of compression applied to the audio. The state in which no compression is applied is defined as "1."
ATTACK	This sets the time until compression starts when audio exceeding the threshold is input.
RELEASE	This adjusts the length of time until compression ends after audio falls below the threshold.
AUTO GAIN	This switches the auto makeup gain feature on and off. When this is set to "ON," the final output volume level after applying the compressor is automatically adjusted according to the "THRESHOLD" and "RATIO" settings. The total of the "MAKEUP GAIN" setting value described below and the value calculated by auto makeup gain becomes the final output volume level (up to +34 dB).
MAKEUP GAIN	This adjusts the final output volume level after applying the compressor.

MEMO

When the compressor is turned on, the COMP/LMT indicator lights up while compression is applied to the input audio.

Equalizer (EQ)

This adjusts the sound quality for each frequency band.

Menu item	Explanation
EQ Hi	This boosts or attenuates the high band.
EQ Hi FREQ	This adjusts the center frequency when changing the sound quality in the high band.
EQ Mid	This boosts or attenuates the middle band.
EQ Mid FREQ	This adjusts the center frequency when changing the sound quality in the middle band.
EQ Mid Q	This adjusts the width of the frequency band when boosting or attenuating the middle band.
EQ Lo	This boosts or attenuates the low band.
EQ Lo FREQ	This adjusts the center frequency when changing the sound quality in the low band.

Applying Effects to Output Audio

This applies effects and adjusts the sound quality for master out and AUX-bus audio.

* Only the limiter can be used on AUX-bus audio (p. 25).

1. Select the [MENU] button → “AUDIO OUTPUT” → “MASTER OUT” or “AUX.”

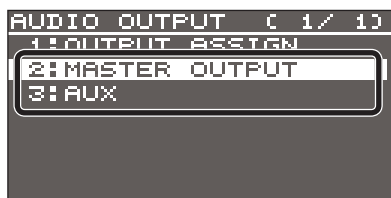

2. Select an effect menu item, then use the [VALUE] knob to adjust it.

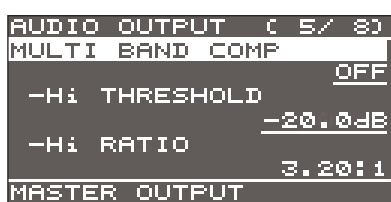

* For more information about effects, refer to the following section.

3. Press the [VALUE] knob to apply the setting.
4. Press the [MENU] button to quit the menu.

Equalizer (EQ)

* MASTER OUTPUT only

This adjusts the sound quality for each frequency band.

Menu item	Explanation
EQ Hi	This boosts or attenuates the high band.
EQ Hi FREQ	This adjusts the center frequency when changing the sound quality in the high band.
EQ Mid	This boosts or attenuates the middle band.
EQ Mid FREQ	This adjusts the center frequency when changing the sound quality in the middle band.
EQ Mid Q	This adjusts the width of the frequency band when boosting or attenuating the middle band.
EQ Lo	This boosts or attenuates the low band.
EQ Lo FREQ	This adjusts the center frequency when changing the sound quality in the low band.

Multi-band compressor (MULTI BAND COMP)

* MASTER OUTPUT only

This applies separate compressors in individual frequency bands.

Menu item	Explanation
MULTI BAND COMP	This switches the multi-band compressor on and off.
Hi THRESHOLD Mid THRESHOLD Lo THRESHOLD	These set the individual levels that become the thresholds for the high, midrange, and low bands at which the compressor is applied. Compression is applied to audio that exceeds the threshold.
Hi RATIO Mid RATIO Lo RATIO	These set the amount of compression applied in the high, midrange, and low bands. The state in which no compression is applied is defined as “1.”

Limiter (LIMITER)

This limits the output volume so that it does not exceed the set level.

Menu item	Explanation
LIMITER	This sets the limiter on or off.
THRESHOLD	This sets the level that becomes the threshold at which the limiter is applied. Compression is applied to audio that exceeds the threshold. The volume level of audio that is output is limited so as to stay below the threshold.

Controlling Volume Levels Automatically (Auto Mixing)

This automatically controls operations that normally are performed by an operator (Auto Mixing feature).

It lets you rely on the V-60HD to perform complex volume-adjustment operations, enabling use in circumstances where no dedicated operator is assigned. This is especially useful for meetings, discussions, debates, and other situations where multiple microphones are used.

1. Follow the procedure in “Adjusting the Head Amp Gain” (p. 24) to adjust the head amp gain for AUDIO IN 1 through 4.
2. Press the [AUTO MIXING] button to turn on the Auto Mixing feature (making the button light up).



3. Select the [MENU] button → “AUDIO AUTO MIXING.”

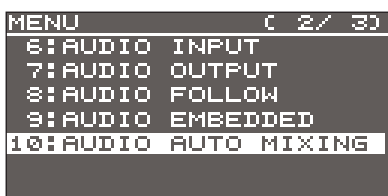

4. Select the audio to use with Auto Mixing, then use the [VALUE] knob to set it to “ON.”

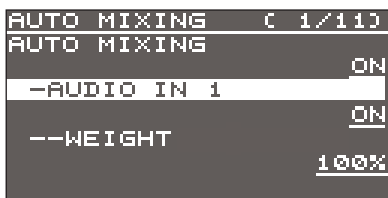

Set audio where Auto Mixing is not needed, such as background music, to “OFF.”

5. Press the [VALUE] knob to apply the setting.
6. Set “WEIGHT,” then use the [VALUE] knob to set the priority level for volume-level distribution (from 0 to 100%).

If there is audio that you want to make more prominent, such as when you want to raise the volume level of an emcee microphone, raise the weight level of that audio to emphasize it, and lower the weight level for other audio.

MEMO

- On audio to which Auto Mixing is applied, setting the weight level to “0%” results in no audio output.
- When air-conditioner noise or the like is a concern, set the weight level to a low value.

7. Press the [VALUE] knob to apply the setting.
Repeat steps 4 through 7 as needed.
8. Press the [MENU] button to quit the menu.
9. To turn off the Auto Mixing feature, press the [AUTO MIXING] button a second time.

Muting Out Specific Input Audio (Mute)

You can temporarily silence specific input audio (Mute feature).

Muting input audio

1. Select the [MENU] button → “AUDIO INPUT” → the input audio.

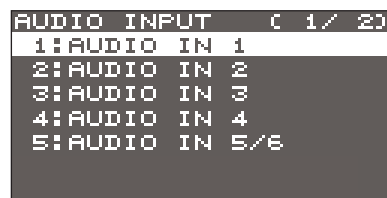

2. Select “INPUT MUTE,” then use the [VALUE] knob to set it to “ON.”



To cancel muting, set this to “OFF.”

3. Press the [VALUE] knob to apply the setting.
4. Press the [MENU] button to quit the menu.

Muting output audio

This mutes out master out and AUX-bus audio (p. 25).

1. Select the [MENU] button → “AUDIO OUTPUT” → “MASTER OUT” or “AUX.”



2. Select “OUTPUT MUTE” or “AUX MUTE,” then use the [VALUE] knob to set it to “ON.”

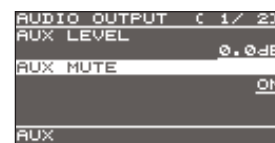
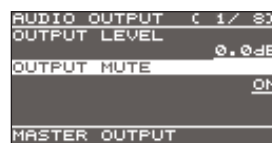

To cancel muting, set this to “OFF.”

3. Press the [VALUE] knob to apply the setting.
4. Press the [MENU] button to quit the menu.

Interlinking Audio Output to Video Switching (Audio Follow)

You can associate audio with a video switch so that when the video is switched, the specified audio alone is output automatically, and other audio is automatically muted.

NOTE

When the Audio Follow feature is turned on, switching between audio output and muting is carried out automatically. The positions of the controls used to adjust the volume level do not change automatically.

1. Follow the procedure in “Adjusting the Volume Level” (p. 24) to adjust to the volume level you want to output.

2. Select the [MENU] button → “AUDIO FOLLOW”

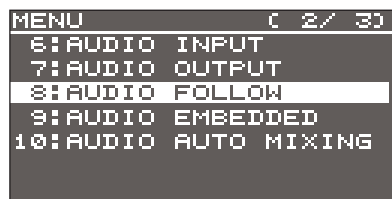

3. Select the video channel you want to use with Audio Follow, then use the [VALUE] knob to set it to “ON.”

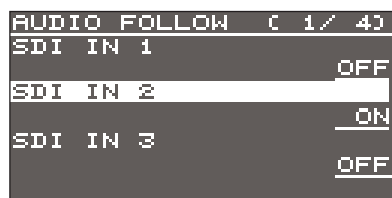

Value	Explanation
ON	This enables the Audio Follow feature. Muting is performed automatically when video on another channel is output.
OFF	This disables the Audio Follow feature.

4. Press the [VALUE] knob to apply the setting.

5. Press the [MENU] button to quit the menu.

6. Switch the video.

On video channels where Audio Follow is on, audio is automatically muted when video on other channels is output.

MEMO

You can check the Audio Follow settings by examining the channel section of the multi-view monitor. Video channels for which Audio Follow is turned on are displayed together with an “A.F” symbol.



Applying audio follow to AUDIO IN 1–5/6

1. Select the [MENU] button → “AUDIO FOLLOW.”

2. From among “AUDIO IN 1” through “AUDIO IN 5/6,” select the input audio you want to use with Audio Follow.

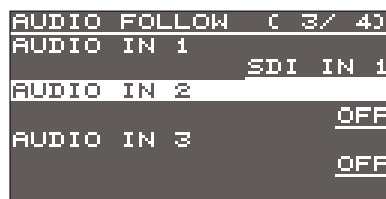

3. Use the [VALUE] knob to specify the video channel to use with Audio Follow.

Value	Explanation
SDI IN 1–4	This sets the video channel to interlink with input audio using Audio Follow.
HDMI IN 5	Audio from AUDIO IN 1–5/6 is muted out for video channels other than what you specified.
HDMI/RGB IN 6	
STILL/BKG IN 7 and 8	
OFF	This assigns no video channel to Audio Follow.

4. Press the [VALUE] knob to apply the setting.

5. Press the [MENU] button to quit the menu.

Separating Discrete Analog Input Audio Streams and Adding Them to SDI Video

The SDI OUT connectors on the V-60HD accommodate eight channels of embedded audio. In addition to two channels for master out (or the AUX bus), you can separate the six discrete channels of analog input audio (AUDIO IN 1 through 5/6) and add them to SDI video.

* The HDMI OUT connectors accommodate two channels of embedded audio (master out or the AUX bus).

The audio shown below is assigned to the respective channels of SDI embedded audio.

SDI embedded-audio channel number	Assigned audio
Channel 1	Master out (L) or AUX bus (L)
Channel 2	Master out (R) or AUX bus (R)
Channel 3	AUDIO IN 1
Channel 4	AUDIO IN 2
Channel 5	AUDIO IN 3
Channel 6	AUDIO IN 4
Channel 7	AUDIO IN 5 (L)
Channel 8	AUDIO IN 6 (R)

Using this feature lets you separate up to six discrete channels of analog input audio and add it to SDI video.

As a backup for visual or sound recording...

Digital audio is extracted from the SDI embedded audio one channel at a time, so after visual recording or sound recording, you can edit the audio channel by channel.

For multilingual support...

Taking multilingual narration or other such audio, making it embedded audio and adding it to SDI video lets you later extract and use the digital audio for the required language.

1. Select the [MENU] button → "AUDIO EMBEDDED."

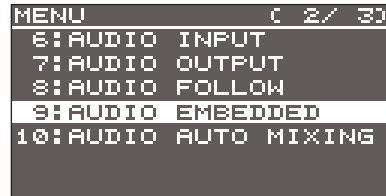

2. From among "AUDIO IN 1" through "AUDIO IN 5/6," select the input audio you want to send to the SDI embedded-audio channel.

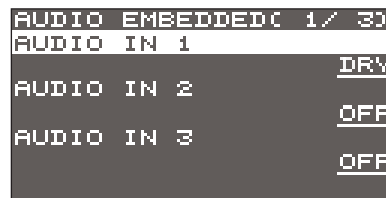

3. Use the [VALUE] knob to set the audio type to "DRY" or "WET."

Value	Explanation
OFF	No audio is sent.
DRY	This sends the source audio with no effects applied.
WET	This sends the effect-applied audio.

4. Press the [VALUE] knob to apply the setting.

Repeat steps 2 through 4 as needed.

5. Select "SDI OUT 1 AUDIO" or "SDI OUT 2 AUDIO," then use the [VALUE] knob to set it to "CH1-8."



Audio containing channels 3 to 8 of embedded audio is output from the SDI OUT connector set to "CH1-8."

6. Press the [VALUE] knob to apply the setting.

7. Press the [MENU] button to quit the menu.

Other Features

Saving/Recalling Settings (Preset Memory)

You can take the current settings, including video and audio settings and the state of the operation panel, and save them as a single set in memory, for later recall and use when needed. The V-60HD is provided with eight preset memories.

About the last memory function

The V-60HD has a built-in Last Memory feature. Last Memory is a feature that saves the state of the unit that is in effect immediately before power-down, and automatically restores the state at the next startup.

The Last Memory feature is enabled by default. When you want to call up a specified preset memory at startup, use the [MENU] button → "PRESET MEMORY" → "START UP" to specify the memory number.

Saving to a preset memory

NOTE

When you have selected the [MENU] button → "PRESET MEMORY" → "MEMORY PROTECT" and set this to "ON," settings cannot be saved to a preset memory.

1. Press the [MODE] button to make it light up in blue.

Each press of the [MODE] button makes it toggle between lighting up in blue and in green.

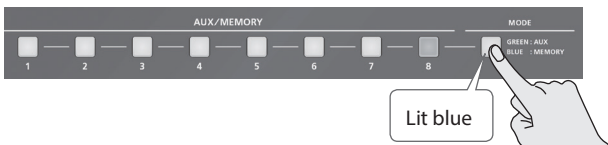

The AUX/MEMORY buttons function as memory selection buttons. The currently selected AUX/MEMORY button lights up in blue.

2. Press and hold (for 2 seconds or longer) the AUX/MEMORY button for the number where you want to save the settings.

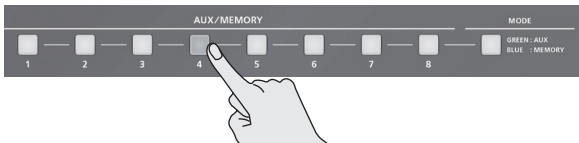

All AUX/MEMORY buttons briefly light up in blue, and the current settings are saved.

MEMO

- The state of the [OUTPUT FADE] button and [PHONES] knob are not saved to any preset memory. The [OUTPUT FADE] button is always dark at startup.
- The state of the [MODE] button and the settings shown below are saved as global settings for the unit. They are not saved to preset memories.

Category	Setting items saved in the unit
RS-232/GPI	All menu items
LAN CONTROL	
SYSTEM	All setting items except "TEST PATTERN" and "TEST TONE" * "TEST PATTERN" and "TEST TONE" are always set to "OFF" at startup.

- You can use the [MENU] button → "PRESET MEMORY" → "SAVE" or "LOAD" to save or load a preset memory.

Recalling a preset memory

1. Press the [MODE] button to make it light up in blue.

Each press of the [MODE] button makes it toggle between lighting up in blue and in green.

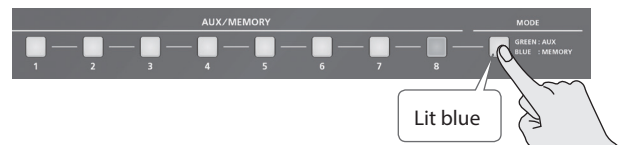

The AUX/MEMORY buttons function as memory selection buttons. The currently selected AUX/MEMORY button lights up in blue.

2. Press the AUX/MEMORY button for the number whose setting you want to recall.

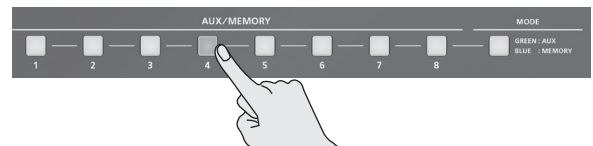

The settings are recalled.

Deleting a preset memory

1. Select the [MENU] button → "PRESET MEMORY" → "DELETE."



2. Use the [VALUE] knob to select the memory number (1 through 8) that you want to delete, then press the [VALUE] knob.

A confirmation message appears.

If you want to cancel the operation, press the [EXIT] button.

3. Use the [VALUE] knob to select "YES," then press the [VALUE] knob.

The preset memory is deleted.

4. Press the [MENU] button to quit the menu.

Saving the Unit's Settings on a USB Flash Drive

You can group together the unit's settings into a single file (*.V06) and save it to a USB flash drive connected to the USB MEMORY port. You can access the saved file (*.V06) on the USB flash drive and load it into the unit for use when needed.

- * When you're using a USB flash drive for the first time, be sure to format it on the V-60HD (p. 33).
- * Depending on the USB flash drive, recognition of the flash drive might take some time.

Saving a new settings file

1. Select the [MENU] button → "USB MEMORY" → "SAVE AS PRESET."



2. With the cursor positioned at "ENTER," press the [VALUE] knob. The USB SAVE AS screen is displayed.

3. Enter the file name.



1. Use the [VALUE] knob to move the cursor. Moving the cursor to a location where no character is present increases the number of characters.
2. Press the [VALUE] knob to highlight the character at the cursor location.
3. Use the [VALUE] knob to change the character, then press the [VALUE] knob to accept the change.
 - Pressing the [EXIT] button deletes the character at the cursor location.
 - You can enter a text string of up to 9 characters in length.
 - The extension of the file name is "V06."
4. When you finish entering the name, use the [VALUE] knob to select "SAVE," then press the [VALUE] knob. A confirmation message appears. If you want to cancel the operation, press the [EXIT] button.
5. Use the [VALUE] knob to select "YES," then press the [VALUE] knob. The file (*.V06) is newly saved on the USB flash drive.
6. Press the [MENU] button to quit the menu.

MEMO

Still images (p. 18) are not saved in the file (*.V06).

Overwrite-saving a settings file

1. Select the [MENU] button → "USB MEMORY" → "SAVE PRESET."
2. With the cursor positioned at "ENTER," press the [VALUE] knob. The USB SAVE screen is displayed.
3. Select the file to overwrite, then press the [VALUE] knob.

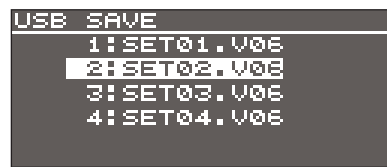

A confirmation message appears. If you want to cancel the operation, press the [EXIT] button.

4. Use the [VALUE] knob to select "YES," then press the [VALUE] knob. The file is saved by overwriting.
5. Press the [MENU] button to quit the menu.

Recalling

This loads settings that are in a preset memory (1 through 8) saved on a USB flash drive. Loading settings overwrites the preset memory on the unit.

1. Select the [MENU] button → "USB MEMORY" → "LOAD PRESET."
2. With the cursor positioned at "ENTER," press the [VALUE] knob. The USB LOAD screen is displayed.
3. Select the file (*.V06) you want to recall, then press the [VALUE] knob.

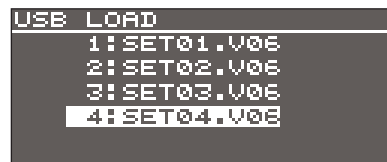

A confirmation message appears. If you want to cancel the operation, press the [EXIT] button.

4. Use the [VALUE] knob to select "YES," then press the [VALUE] knob. The settings are recalled, and the values in the unit's preset memories are overwritten.
5. Press the [MENU] button to quit the menu.

Formatting USB Flash Drives

When using a USB flash drive for the first time, be sure to format it on the V-60HD.

NOTE

- The V-60HD does not recognize unformatted USB flash drives.
- Use a commercially available USB flash drive or a USB flash drive sold by Roland. However, we cannot guarantee that all commercially available USB flash drives will work with this unit.
- Performing formatting causes all data already saved on the USB flash drive to be deleted. If the flash drive contains necessary data, back it up onto a computer or elsewhere before formatting the drive.

Making the connection

1. Connect the USB flash drive to the USB MEMORY port.

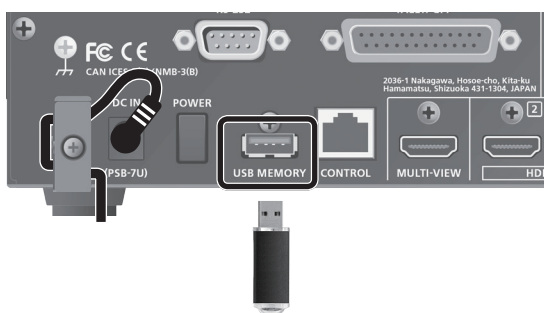

* Be careful to orient the USB flash drive correctly front and back and in the correct direction for insertion, and insert it firmly, as far as it will go. Never insert using undue force.

Performing formatting

1. Select the [MENU] button → “USB MEMORY” → “FORMAT.”



A confirmation message appears.
If you want to cancel the operation, press the [EXIT] button.

2. Use the [VALUE] knob to select “YES,” then press the [VALUE] knob.
Formatting of the USB flash drive is carried out.
3. Press the [MENU] button to quit the menu.

Returning Settings to the Factory-default State (Factory Reset)

You can return the values of settings on the V-60HD to their factory defaults.

If operation that differs from what is described in the owner's manual occurs even when the steps described are followed correctly, try performing a factory reset.

NOTE

Executing a factory reset causes all values that have been set, settings saved in preset memories (p. 31), and still images saved in the unit to be lost.

1. Select the [MENU] button → “SYSTEM” → “FACTORY RESET.”

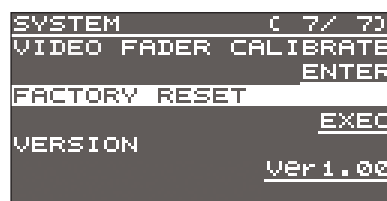

A confirmation message appears.
If you want to cancel the operation, press the [EXIT] button.

2. Use the [VALUE] knob to select “YES,” then press the [VALUE] knob.
A factory reset is executed.
3. Press the [MENU] button to quit the menu.

Preventing Unintended Operation (Panel Lock)

This locks operation of buttons and knobs to prevent unintended operation of the V-60HD.

1. Select the [MENU] button → “SYSTEM” → “PANEL LOCK.”

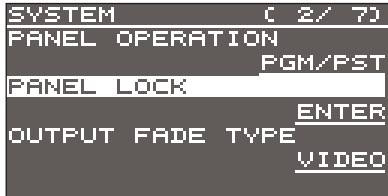

2. With the cursor positioned at “ENTER,” press the [VALUE] knob. The PANEL LOCK menu appears.
3. Select a target for panel lock, then use the [VALUE] knob to specify whether panel lock is applied (ON) or not applied (OFF).

You can select the following menu items as targets for panel lock.

Menu item	Target of panel lock
ALL SW & VOLUME	All buttons and knobs
MENU SW + EXIT SW	[MENU] and [EXIT] buttons
VALUE ENCODER	[VALUE] knob
PGM/A 1–8 SW	PGM/A bus cross-point [1]–[8] buttons
PST/B 1–8 SW	PST/B bus cross-point [1]–[8] buttons
AUX/MEMORY 1–8 SW	AUX/MEMORY buttons (All)
MODE SW	[MODE] button
CUT SW + AUTO SW	[CUT] and [AUTO] buttons
VIDEO FADER	Video fader
OUTPUT FADE SW	[OUTPUT FADE] button
DSK ON/OFF SW	[DSK] button
COMPOSITION BLOCK	[H/PGM-CTR] and [V/PST-CTR] knobs [PinP 1], [PinP 2], and [SPLIT] buttons
TRANSITION BLOCK	[MIX], [WIPE 1], and [WIPE 2] buttons [TIME] knob
DSK BLOCK	[LEVEL] and [GAIN] knobs [PVW] button
AUDIO IN 1–6 VOLUME	AUDIO INPUT LEVEL knobs (All)
AUTO MIXING SW	[AUTO MIXING] button
MASTER OUTPUT VOLUME	[MASTER OUTPUT] knob

4. Press the [VALUE] knob to apply the setting. Repeat steps 3 and 4 as needed.
5. Press the [MENU] button to quit the menu.
6. Press and hold the [EXIT] button and the [MENU] button at the same time (for 3 seconds or longer).

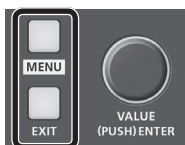

The message “PANEL LOCKED” is displayed, and panel lock is turned on. The button and controls that you set to applied (ON) in step 3 are locked.

7. To turn off panel lock, again press and hold the [EXIT] button and the [MENU] button at the same time (for 3 seconds or longer).

The message “LOCK RELEASED” is displayed, and panel lock is turned off.

Operating the V-60HD by Remote Control

You can operate the V-60HD remotely from an external device.

Using the dedicated V-60HD RCS program

You can connect the V-60HD to a computer via a LAN or RS-232, and use dedicated program V-60HD RCS to operate the unit by remote control.

For more information about operation methods, refer to the owner’s manual included with V-60HD RCS.

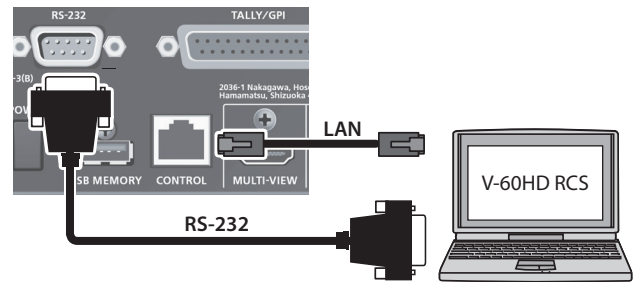

V-60HD RCS can be downloaded from the following Roland website.

<https://proav.roland.com/>

Using RS-232/LAN/GPI

You can operate the V-60HD remotely from an external device by means of RS-232/LAN (CONTROL port)/GPI.

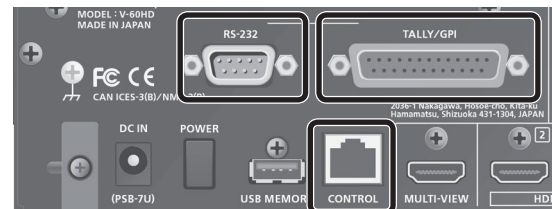

For the specifications of the RS-232 connector and the TALLY/GPI connector and for more information on operating the unit remotely, refer to the Reference Manual (PDF), available for download at the Roland website shown above.

Outputting a Tally Signal

You can output a tally signal from the TALLY/GPI connector.

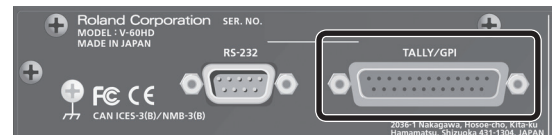

A tally signal is output from the connector pin corresponding to the video channel being output, also including video composition and transition effects.

For the specifications of the TALLY/GPI connector, refer to the Reference Manual (PDF), available for download at the Roland website shown above.

Appendices

Troubleshooting

If you suspect a malfunction, please check the following points. If this does not resolve the problem, contact a nearby Roland Service Center.

Problem	Items to check	Action	Page
Video-related problems			
No picture is input.	When the [MODE] button is lighted in green, are the AUX/MEMORY buttons flashing in green?	Video in a format that differs from the setting on the V-60HD is being input. Set the system format to match the connected device.	p. 12
	Has the video source been correctly assigned to channel 6?	Specify the video source to assign to channel 6.	p. 13
	Is copyright-protected (HDCP) video being input?	When inputting copyright-protected (HDCP) video signals, go to the SETUP menu and set "HDCP" to "ON."	p. 15
Video from the computer is not displayed.	Is the format of the video output from the computer compatible with the V-60HD's input formats?	The supported input formats on channels 1 through 4 are 1080p, 1080i, and 720p. Only channels 5 and 6 supports VESA-standard resolutions.	p. 12
Video from the computer is corrupted.	When a rapidly moving video is input from a computer, out-of-sync motion, flicker, or other picture corruption may occur.	This is called "tearing," and does not indicate an equipment malfunction.	—
No picture is output.	Is "HDCP" set to "ON"?	When "HDCP" is set to "ON," video is output only from the HDMI OUT and MULTI-VIEW connectors. No video is output via the SDI OUT connectors.	p. 15
	Is the [OUTPUT FADE] button lighted?	When the [OUTPUT FADE] button is lighted, a fade is applied to the final output video. To output the video, press the [OUTPUT FADE] button to make it go dark.	p. 20
	Is the display connected correctly?	When outputting copyright-protected (HDCP) video, connect an HDCP-compatible display.	p. 15
"Snowy"-noise video is output.	It is possible that the HDMI signal is not being sent and received correctly.	Reconnect the HDMI cable.	—
The colors on the monitor screen connected via HDMI are incorrect.	Do the color-space settings for any monitors connected to the HDMI OUT connectors or the MULTI-VIEW connector match the color-space setting on the V-60HD?	Use VIDEO OUTPUT menu → "HDMI OUT 1," "HDMI OUT 2," or "HDMI MULTI-VIEW" → "COLOR SPACE" to change the setting.	p. 13
		Depending on the device, the color space might be interlinked with the selection of DVI or HDMI or the selected format. In such cases, changing the color space on the output device might bring about improvement for the problem.	—
HDMI output shown on a display has its periphery cut off.	Are the display settings compatible?	In the case of HDMI signals, automatic overscan occurs on some displays. Change the display's settings.	—
Compositing a logo or video cannot be accomplished.	Has the correct key type (extraction color) been selected for DSK?	Go to the DSK menu and use "KEY TYPE" to select the key type (extraction color) to match the background color of the logo or video.	p. 23
		Use the [LEVEL] and [GAIN] knobs to adjust the position to just the right degree of extraction for the logo or image.	
Still-image cannot be imported.	Are you importing a still image whose format and resolution are supported by the V-60HD?	Still images of unsupported formats or resolutions are not recognized. Prepare a still image whose format and resolution are supported by the V-60HD.	p. 19
	Does still image have a proper file name?	Use a file name composed of no more than 8 single-byte alphanumeric characters. Also, be sure to append the "*.bmp" file extension. Still images without proper file names are not recognized.	
Audio-related Problems			
No audio is output. Audio volume is low.	Is the volume turned down on the V-60HD?	Adjust each input to an appropriate volume level. Also, use the [MASTER OUTPUT] knob to adjust the volume level for master out.	p. 25
	Is head amp gain turned down for AUDIO IN 1 through 4?	When head amp gain is turned down, no audio is output even when the volume level is raised. Adjust the head amp gain.	p. 24
	Is a condenser microphone connected?	When connecting a condenser microphone or other device requiring phantom power, select the [MENU] button → "AUDIO INPUT" → "AUDIO IN 1" through "AUDIO IN 4" → set "PHANTOM +48V" to "ON."	p. 9
Other Problems			
Buttons and knobs cannot be operated.	Is panel lock turned on?	When the message "OPERATION LOCKED" is shown on the built-in display, panel lock is turned on. Press and hold the [EXIT] button and the [MENU] button at the same time (for 3 seconds or longer) to turn off panel lock.	p. 34
Switching is not complete even when the video fader is moved.	Factors such as continued use and transportation can sometimes cause the video to fail to be switched completely.	Perform calibration of the video fader. Go to the SYSTEM menu, then select and execute "VIDEO FADER CALIBRATE."	—
A USB flash drive cannot be read.	Has the USB flash drive been formatted on the V-60HD?	The V-60HD does not recognize unformatted USB flash drives. Format the USB flash drive before using it for the first time.	p. 33

Block Diagram

Video Section

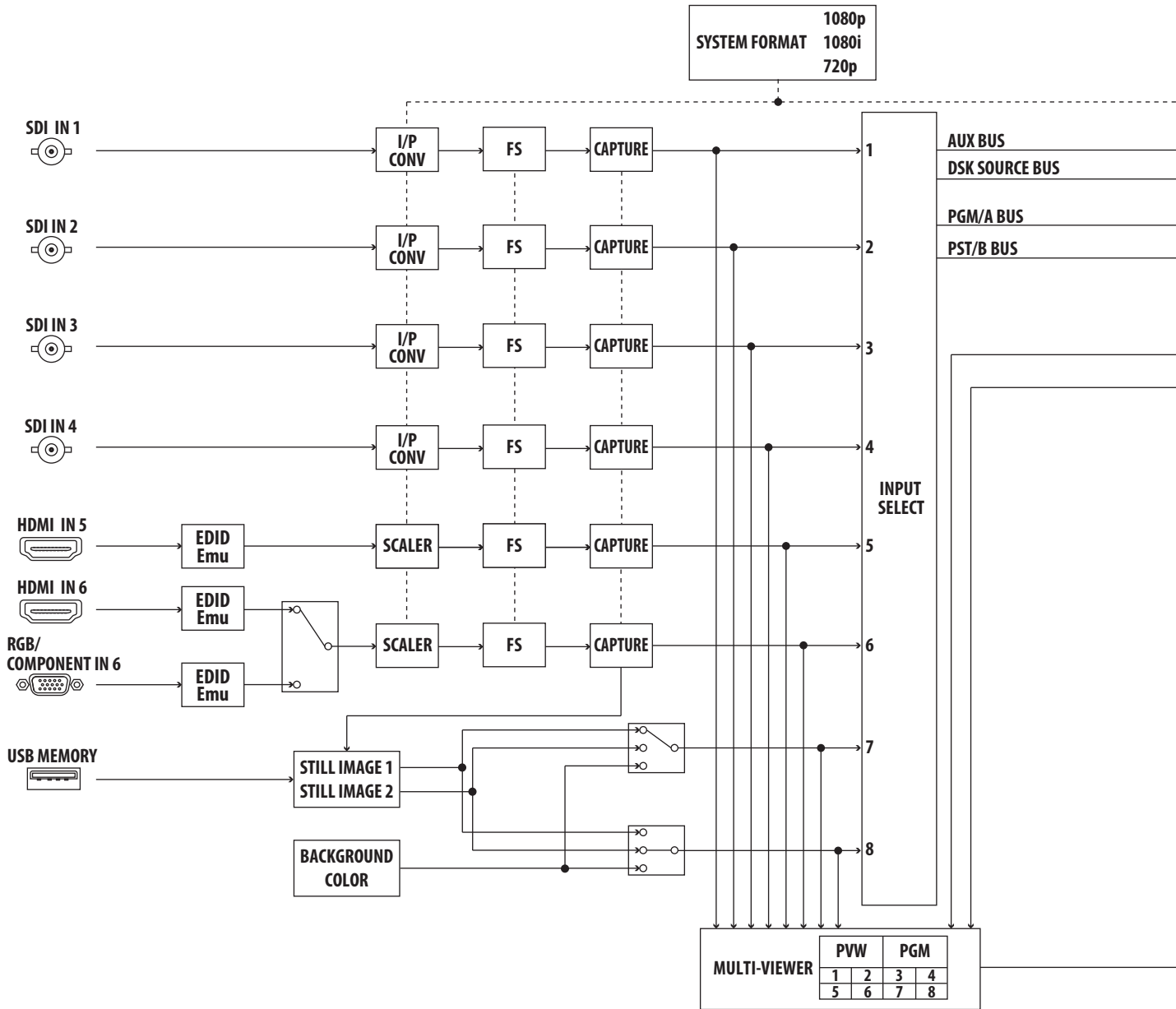

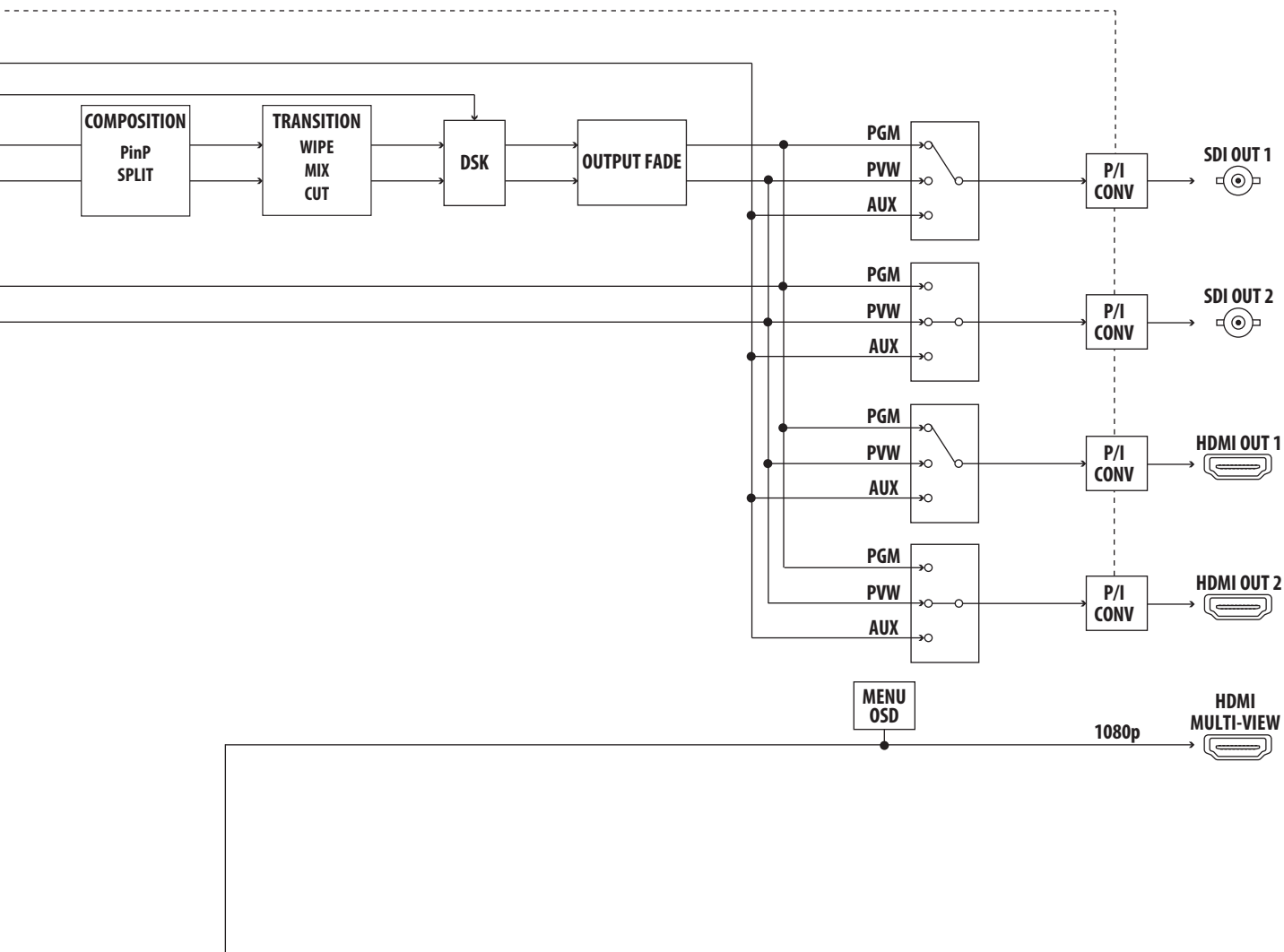

Audio Section

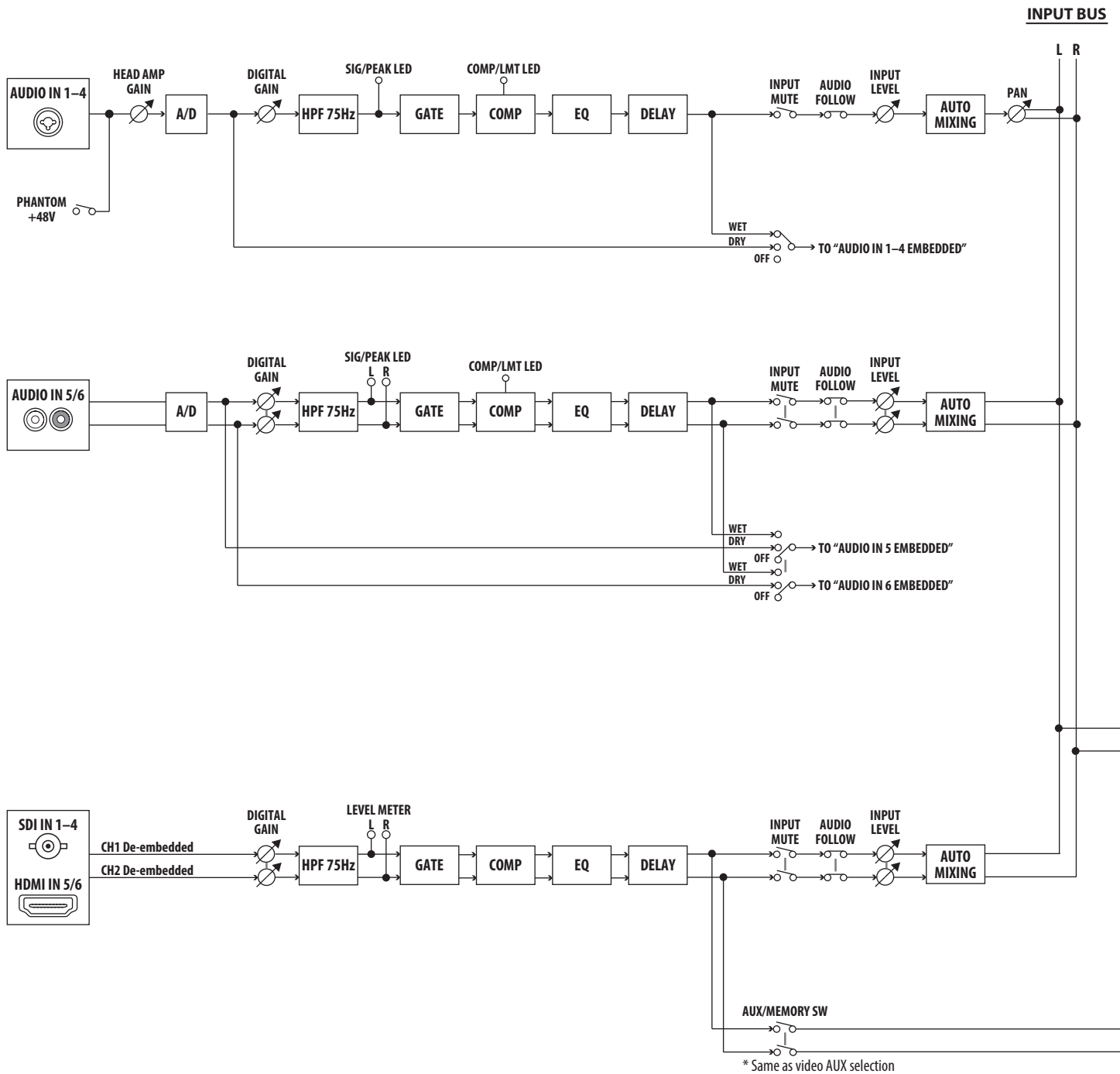

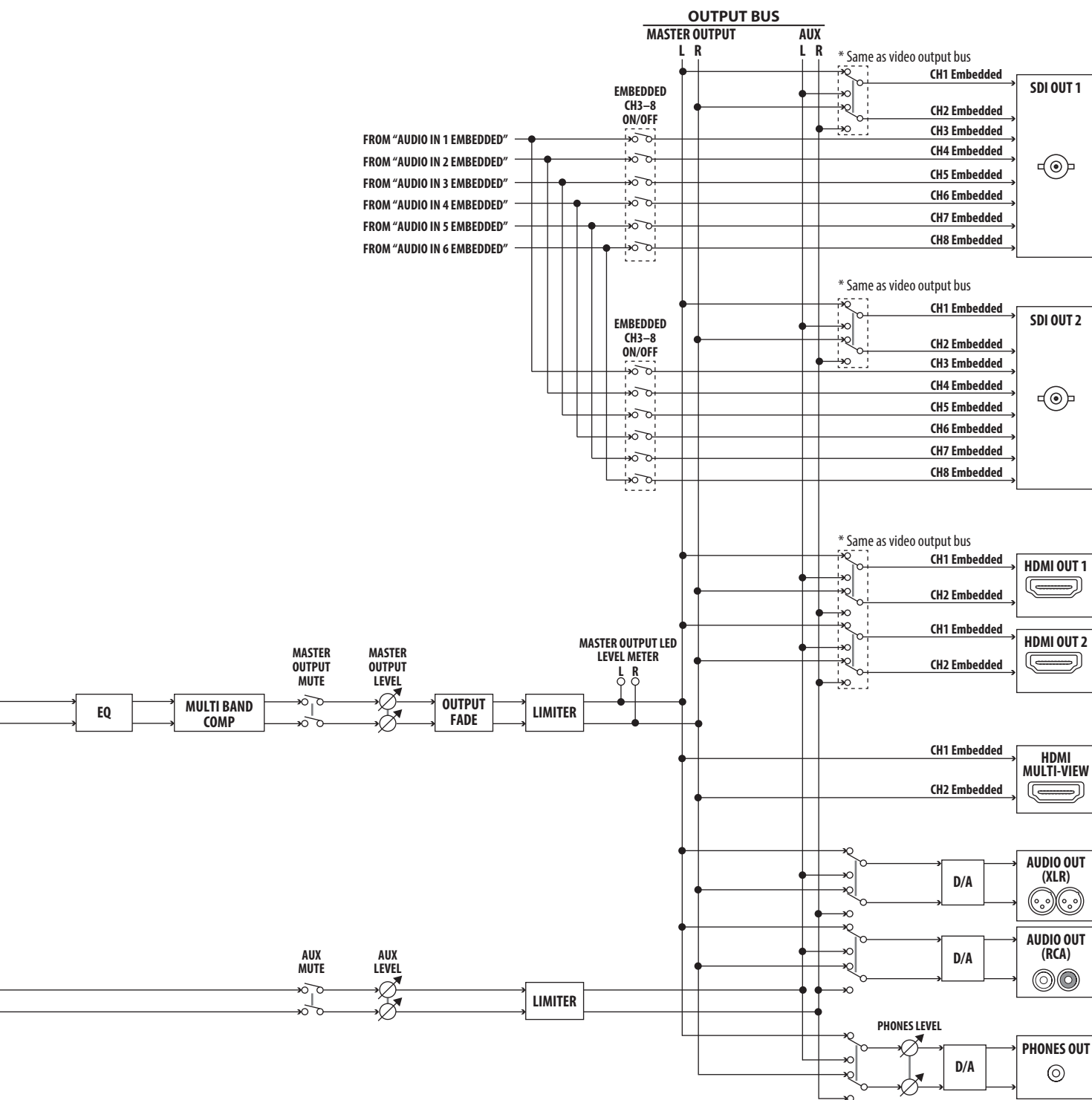

Main Specifications

Roland V-60HD: HD Video Switcher

Video		
Video Processing	4:2:2 (Y/Pb/Pr), 8-bit	
Input Connectors	SDI IN 1–4	BNC type x 4 * Conforms to SMPTE 424M (SMPTE 425M-AB), 292M
	HDMI IN 5–6	HDMI type A x 2 * HDCP Supported * Multi-format Supported
	RGB/COMPONENT IN 6	HD DB-15 type x 1 * INPUT 6: HDMI or RGB/COMPONENT selected. * Multi-format Supported
Output Connectors	SDI OUT 1–2	BNC type x 2 * Conforms to SMPTE 424M (SMPTE 425M-AB), 292M
	HDMI OUT 1–2	HDMI type A x 2 * HDCP Supported
	HDMI MULTI-VIEW	HDMI type A x 1 * HDCP Supported
Input Formats *1 *2	SDI IN 1–4 *3	720/59.94p, 720/50p (SYSTEM FORMAT: 720p) 1080/59.94i, 1080/50i, 1080/59.94p, 1080/50p (SYSTEM FORMAT: 1080i, 1080p)
	HDMI IN 5–6 RGB/COMPONENT IN 6	480/59.94i, 576/50i, 480/59.94p, 576/50p, 720/59.94p, 720/50p, 1080/59.94i, 1080/50i, 1080/59.94p 1080/50p VGA (640 x 480/60 Hz), SVGA (800 x 600/60 Hz), XGA (1024 x 768/60 Hz), WXGA (1280 x 800/60 Hz) SXGA (1280 x 1024/60 Hz), FWXGA (1366 x 768/60 Hz), SXGA+ (1400 x 1050/60 Hz) UXGA (1600 x 1200/60 Hz), WUXGA (1920 x 1200/60 Hz) * The refresh rate is the maximum value of each resolution. * Conforms to CEA-861-E,VESA DMT Version 1.0 Revision 11. * 1920 x 1200/60 Hz: Reduced blanking
	Still Image	Bitmap File (.bmp) * Maximum 1920 x 1080 pixels, 24-bit color, uncompressed. * It can be stored up to 2 files in the internal memory.
Output Formats *2	SDI OUT 1–2 *3	720/59.94p, 720/50p (SYSTEM FORMAT: 720p)
	HDMI OUT 1–2	1080/59.94i, 1080/50i (SYSTEM FORMAT: 1080i) 1080/59.94p, 1080/50p (SYSTEM FORMAT: 1080p)
	HDMI MULTI-VIEW	1080/59.94p, 1080/50p
Video Effects	Transition	CUT, MIX (DISSOLVE/FAM/NAM), WIPE (30 types)
	Composition	PinP (SQUARE, CIRCLE, HEART, DIAMOND), SPLIT (4 types), DSK (Luminance Key, Chroma Key)
	Others	Flip horizontal, Output fade, Still Image Capture, Still Image Playback, Test pattern output

*1: The input interlaced video signal is converted to progressive video signal by internal processing.

*2: The video signal frame rate can be selected at the SYSTEM menu (59.94 Hz or 50 Hz).

*3: Conforms to SMPTE 296M, SMPTE 274M

Audio			
Audio Processing	Sampling rate	24 bits/48 kHz	
Audio Formats	SDI IN	Linear PCM, 24 bits/48 kHz, 2ch (Conforms to SMPTE 299M)	
	SDI OUT	Linear PCM, 24 bits/48 kHz, 8ch (Conforms to SMPTE 299M)	
	HDMI IN/OUT	Linear PCM, 24 bits/48 kHz, 2ch	
Input Connectors	Digital	SDI IN 1–4 HDMI IN 5–6	
	Analog	AUDIO IN 1–4	Combo type (XLR, 1/4-inch TRS phone), phantom power *4 *4: DC 48 V (unloaded maximum), 10 mA (maximum load) * Current value per channel
		AUDIO IN 5–6	RCA phono type
Output Connectors	Digital	SDI OUT 1–2 HDMI OUT 1–2 HDMI MULTI-VIEW	
	Analog	AUDIO OUT	XLR type
		AUDIO OUT	RCA phono type
		PHONES	Stereo 1/4-inch phone type
	Input Level	AUDIO IN 1–4	-60– +4 dBu (Maximum: +22 dBu)
AUDIO IN 5–6		-10 dBu (Maximum: +8 dBu)	

Input Impedance	AUDIO IN 1-4	10 k ohms (HEAD AMP GAIN 0-23 dB), 5 k ohms (HEAD AMP GAIN 24-64 dB)
	AUDIO IN 5-6	15 k ohms
Output Level	AUDIO OUT (XLR)	+4 dBu (Maximum: +22 dBu)
	AUDIO OUT (RCA)	-10 dBu (Maximum: +8 dBu)
	PHONES	92 mW + 92 mW (32 ohms)
Output Impedance	AUDIO OUT (XLR)	600 ohms
	AUDIO OUT (RCA)	1 k ohm
	PHONES	10 ohms

Audio Effects Auto Mixing, EQ, Delay, Compressor, HPF, Gate, Multi-Band Compressor, Limiter

Other Connectors

USB MEMORY	USB A type (for USB drive)
Tally/GPI	DB-25 type (Female, Tally: 12, GPI: 8)
RS-232	DB-9 type (Male, for Remote Control)
CONTROL	RJ45 100BASE-TX (for Remote Control)

Other Functions

Preset Memory (8 types), Panel Lock Function, EDID Emulator, Smart Tally

Display

Graphic LCD: 128 x 64 dots

Other

Power Supply	AC Adaptor	Dimensions	356 (W) x 221 (D) x 96 (H) mm
Current Draw	3.1 A		14-1/16 (W) x 8-3/4 (D) x 3-13/16 (H) inches
Power Consumption	37.0 W	Weight (excluding AC adaptor)	3.0 kg
Operation Temperature	+0 to +40 degrees Celsius		6 lbs 10 oz
Temperature	+32 to +104 degrees Fahrenheit	Accessories	Owner's Manual, AC adaptor, Power cord

* 0 dBu=0.775 Vrms

* This document explains the specifications of the product at the time that the document was issued. For the latest information, refer to the Roland website.

Dimensions

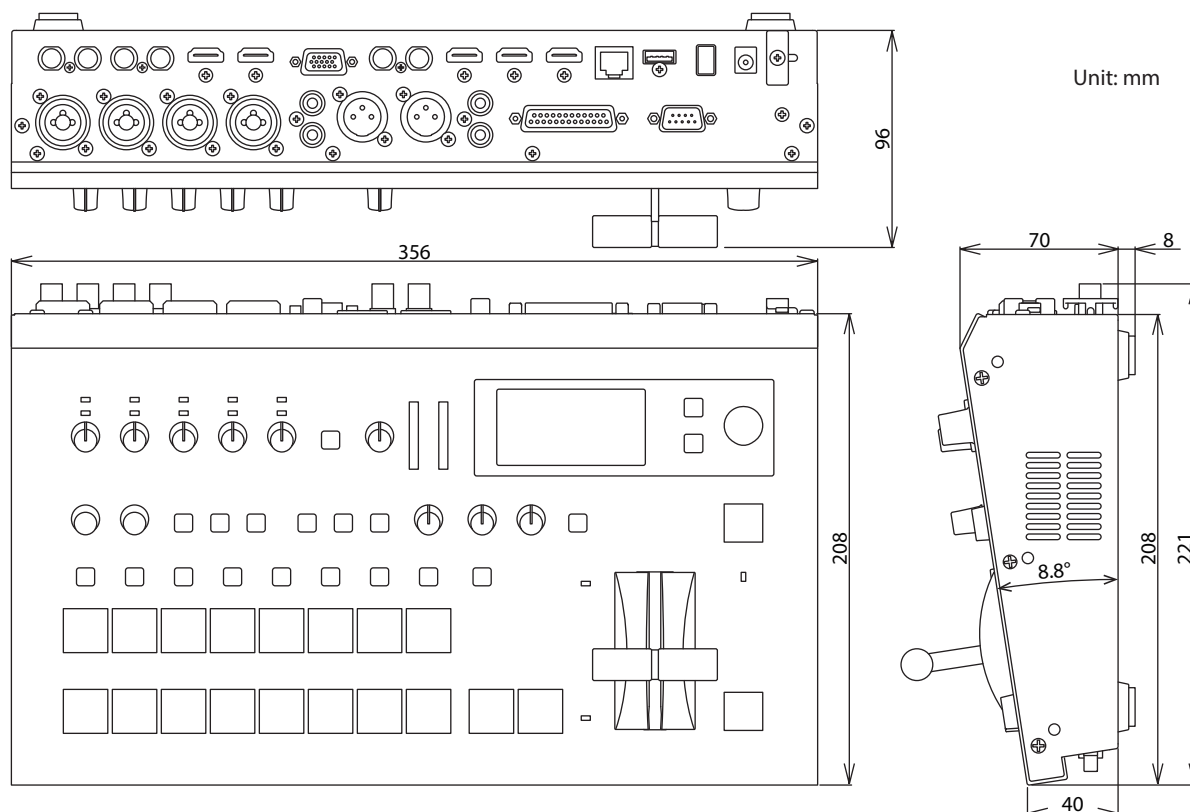

Transition Effects List

MIX



Effect	Explanation
MIX	The two pictures are blended together as the video is switched.
FAM	Video transitions are made with the luminance levels of the two video streams maintained unchanged. * This is an abbreviation of "full additive mix."
NAM	The two video streams are compared, and transitions are made with display during transition starting with levels of high luminance. * This is an abbreviation of "non-additive mix."

WIPE

The original video is broken into by the next video.

Normal

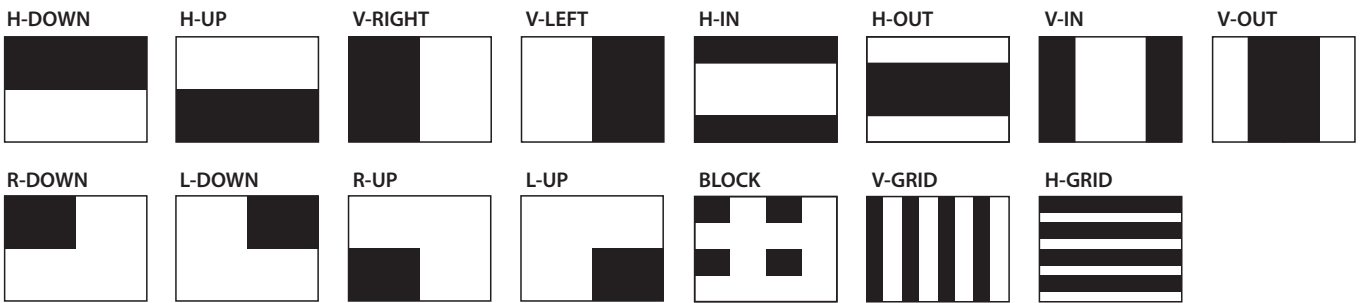

Soft Edge

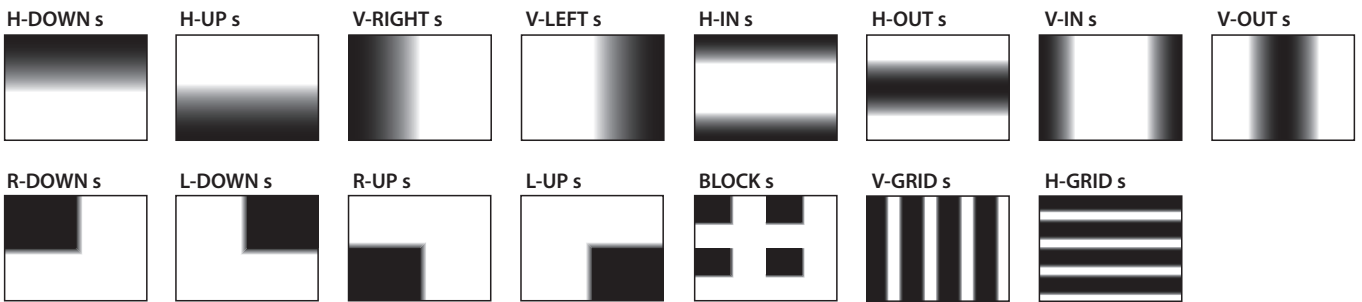

For the U.K.

IMPORTANT: THE WIRES IN THIS MAINS LEAD ARE COLOURED IN ACCORDANCE WITH THE FOLLOWING CODE.

BLUE: NEUTRAL
BROWN: LIVE

As the colours of the wires in the mains lead of this apparatus may not correspond with the coloured markings identifying the terminals in your plug, proceed as follows:

The wire which is coloured BLUE must be connected to the terminal which is marked with the letter N or coloured BLACK.

The wire which is coloured BROWN must be connected to the terminal which is marked with the letter L or coloured RED.

Under no circumstances must either of the above wires be connected to the earth terminal of a three pin plug.

For the USA

FEDERAL COMMUNICATIONS COMMISSION RADIO FREQUENCY INTERFERENCE STATEMENT

This equipment has been tested and found to comply with the limits for a Class B digital device, pursuant to Part 15 of the FCC Rules. These limits are designed to provide reasonable protection against harmful interference in a residential installation. This equipment generates, uses, and can radiate radio frequency energy and, if not installed and used in accordance with the instructions, may cause harmful interference to radio communications. However, there is no guarantee that interference will not occur in a particular installation. If this equipment does cause harmful interference to radio or television reception, which can be determined by turning the equipment off and on, the user is encouraged to try to correct the interference by one or more of the following measures:

- Reorient or relocate the receiving antenna.
- Increase the separation between the equipment and receiver.
- Connect the equipment into an outlet on a circuit different from that to which the receiver is connected.
- Consult the dealer or an experienced radio/TV technician for help.

This device complies with Part 15 of the FCC Rules. Operation is subject to the following two conditions:

(1) this device may not cause harmful interference, and

(2) this device must accept any interference received, including interference that may cause undesired operation.

This equipment requires shielded interface cables in order to meet FCC class B limit.

Any unauthorized changes or modifications not expressly approved by the party responsible for compliance could void the user's authority to operate the equipment.

For Canada

CAN ICES-3 (B)/NMB-3 (B)

For Korea

사용자 안내문

기종별	사용자 안내문
B 급 기기 (가정용 방송통신기자재)	이 기기는 가정용(B 급) 전자파적합기기로서 주로 가정에서 사용하는 것을 목적으로 하며, 모든 지역에서 사용할 수 있습니다.

Manufacturer: 2036-1 Nakagawa, Hosoe-cho, Kita-ku, Hamamatsu, Shizuoka 431-1304, JAPAN

Importer: ENA 23 Zone 1 nr. 1620 Klaus-Michael Kuehnelaan 13, 2440 Geel, BELGIUM



For the USA

DECLARATION OF CONFORMITY Compliance Information Statement

Model Name : V-60HD
Type of Equipment : VIDEO SWITCHER
Responsible Party : Roland Corporation U.S.
Address : 5100 S. Eastern Avenue Los Angeles, CA 90040-2938
Telephone : (323) 890-3700

For EU Countries



- UK** This symbol indicates that in EU countries, this product must be collected separately from household waste, as defined in each region. Products bearing this symbol must not be discarded together with household waste.
- DE** Dieses Symbol bedeutet, dass dieses Produkt in EU-Ländern getrennt vom Hausmüll gesammelt werden muss gemäß den regionalen Bestimmungen. Mit diesem Symbol gekennzeichnete Produkte dürfen nicht zusammen mit dem Hausmüll entsorgt werden.
- FR** Ce symbole indique que dans les pays de l'Union européenne, ce produit doit être collecté séparément des ordures ménagères selon les directives en vigueur dans chacun de ces pays. Les produits portant ce symbole ne doivent pas être mis au rebut avec les ordures ménagères.
- IT** Questo simbolo indica che nei paesi della Comunità europea questo prodotto deve essere smaltito separatamente dai normali rifiuti domestici, secondo la legislazione in vigore in ciascun paese. I prodotti che riportano questo simbolo non devono essere smaltiti insieme ai rifiuti domestici. Ai sensi dell'art. 13 del D.Lgs. 25 luglio 2005 n. 151.
- ES** Este símbolo indica que en los países de la Unión Europea este producto debe recogerse aparte de los residuos domésticos, tal como está regulado en cada zona. Los productos con este símbolo no se deben depositar con los residuos domésticos.
- PT** Este símbolo indica que nos países da UE, a recolha deste produto deverá ser feita separadamente do lixo doméstico, de acordo com os regulamentos de cada região. Os produtos que apresentem este símbolo não deverão ser eliminados juntamente com o lixo doméstico.
- NL** Dit symbool geeft aan dat in landen van de EU dit product gescheiden van huishoudelijk afval moet worden aangeboden, zoals bepaald per gemeente of regio. Producten die van dit symbool zijn voorzien, mogen niet samen met huishoudelijk afval worden verwijderd.
- DK** Dette symbol angiver, at i EU-lande skal dette produkt opsamles adskilt fra husholdningsaffald, som defineret i hver enkelt region. Produkter med dette symbol må ikke smides ud sammen med husholdningsaffald.
- NO** Dette symbolet indikerer at produktet må behandles som spesialavfall i EU-land, iht. til retningslinjer for den enkelte regionen, og ikke kastes sammen med vanlig husholdningsavfall. Produkter som er merket med dette symbolet, må ikke kastes sammen med vanlig husholdningsavfall.

- SE** Symbolen anger att i EU-länder måste den här produkten kasseras separat från hushållsavfall, i enlighet med varje regions bestämmelser. Produkter med den här symbolen får inte kasseras tillsammans med hushållsavfall.
- FI** Tämä merkintä ilmaisee, että tuote on EU-maissa kerättävä erillään kotitalousjätteistä kunkin alueen voimassa olevien määräysten mukaisesti. Tällä merkinnällä varustettuja tuotteita ei saa hävittää kotitalousjätteiden mukana.
- HU** Ez a szimbólum azt jelenti, hogy az Európai Unióban ezt a terméket a háztartási hulladéktól elkülönítve, az adott régióban érvényes szabályozás szerint kell gyűjteni. Az ezzel a szimbóllal ellátott termékeket nem szabad a háztartási hulladék közé dobni.
- PL** Symbol oznacza, że zgodnie z regulacjami w odpowiednim regionie, w krajach UE produktu nie należy wyrzucać z odpadami domowymi. Produktów opatrzonych tym symbolem nie można utylizować razem z odpadami domowymi.
- CZ** Tento symbol udává, že v zemích EU musí být tento výrobek sbírán odděleně od domácího odpadu, jak je určeno pro každý region. Výrobky nesoucí tento symbol se nesmí vyhazovat spolu s domácím odpadem.
- SK** Tento symbol vyjadruje, že v krajinách EÚ sa musí zber tohto produktu vykonávať oddelene od domového odpadu, podľa nariadení platných v konkrétnej krajine. Produkty s týmto symbolom sa nesmú vyhazovať spolu s domovým odpadom.
- EE** See sümbol näitab, et EL-i maades tuleb see toode olemprügist eraldi koguda, nii nagu on igas piirkonnas määratletud. Selle sümboliga märgitud tooteid ei tohi ära visata koos olmeprügiga.
- LT** Šis simbolis rodo, kad ES šalyse šis produktas turi būti surenkamas atskirai nuo buitinių atliekų, kaip nustatyta kiekviename regione. Šiuo simboliu paženklinėti produktai neturi būti išmetami kartu su buitinėmis atliekomis.
- LV** Šis simbols norāda, ka ES valstīs šo produktu jāievāc atsevišķi no mājsaimniecības atkritumiem, kā noteikts katrā reģionā. Produktus ar šo simbolu nedrīkst izmest kopā ar mājsaimniecības atkritumiem.
- SI** Ta simbol označuje, da je treba proizvod v državah EU zbirati ločeno od gospodinskih odpadkov, tako kot je določeno v vsaki regiji. Proizvoda s tem znakom ni dovoljeno odlagati skupaj z gospodinskimi odpadki.
- GR** Το σύμβολο αυτό υποδηλώνει ότι στις χώρες της Ε.Ε. το συγκεκριμένο προϊόν πρέπει να συλλέγεται χωριστά από τα υπόλοιπα οικιακά απορρίμματα, σύμφωνα με όσα προβλέπονται σε κάθε περιοχή. Τα προϊόντα που φέρουν το συγκεκριμένο σύμβολο δεν πρέπει να απορρίπτονται μαζί με τα οικιακά απορρίμματα.

For China

有关产品中所含有害物质的说明

本资料就本公司产品中所含的特定有害物质及其安全性予以说明。

本资料适用于2007年3月1日以后本公司所制造的产品。

环保使用期限



此标志适用于在中国国内销售的电子信息产品，表示环保使用期限的年数。所谓环保使用期限是指在自制造日起的规定期限内，产品中所含的有害物质不致引起环境污染，不会对人身、财产造成严重的不良影响。

环保使用期限仅在遵照产品使用说明书，正确使用产品的条件下才有效。不当的使用，将会导致有害物质泄漏的危险。

产品中有毒有害物质或元素的名称及含量

部件名称	有毒有害物质或元素					
	铅(Pb)	汞(Hg)	镉(Cd)	六价铬(Cr(VI))	多溴联苯(PBB)	多溴二苯醚(PBDE)
外壳(壳体)	X	O	O	O	O	O
电子部件(印刷电路板等)	X	O	X	O	O	O
附件(电源线、交流适配器等)	X	O	O	O	O	O

O: 表示该有毒有害物质在该部件所有均质材料中的含量均在 SJ/T11363-2006 标准规定的限量要求以下。
X: 表示该有毒有害物质至少在该部件的某一均质材料中的含量超出 SJ/T11363-2006 标准规定的限量要求。因根据现有的技术水平, 还没有什么物质能够代替它。

